

pod bay 3

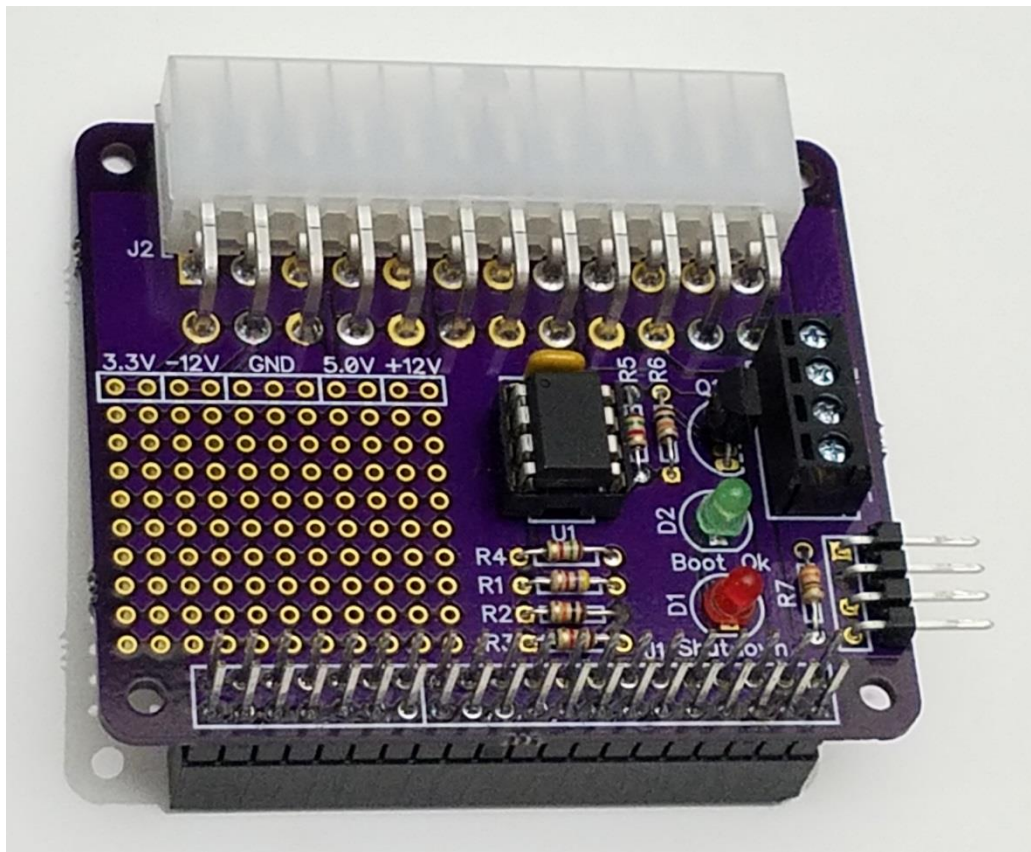

PiRyte Mini ATX PSU Revision 1.1.1 User Manual

PiRyte Mini ATX PSU

Installation and User Guide.

July 13, 2017

Overview

Congratulations on your purchase of the PiRyte Mini ATX PSU!

Please read this entire manual before using to ensure you receive maximum benefit from this board while protecting your investment in your Raspberry Pi/PiRyte stack.

While reading this document, please refer to the graphic below on the following pages.

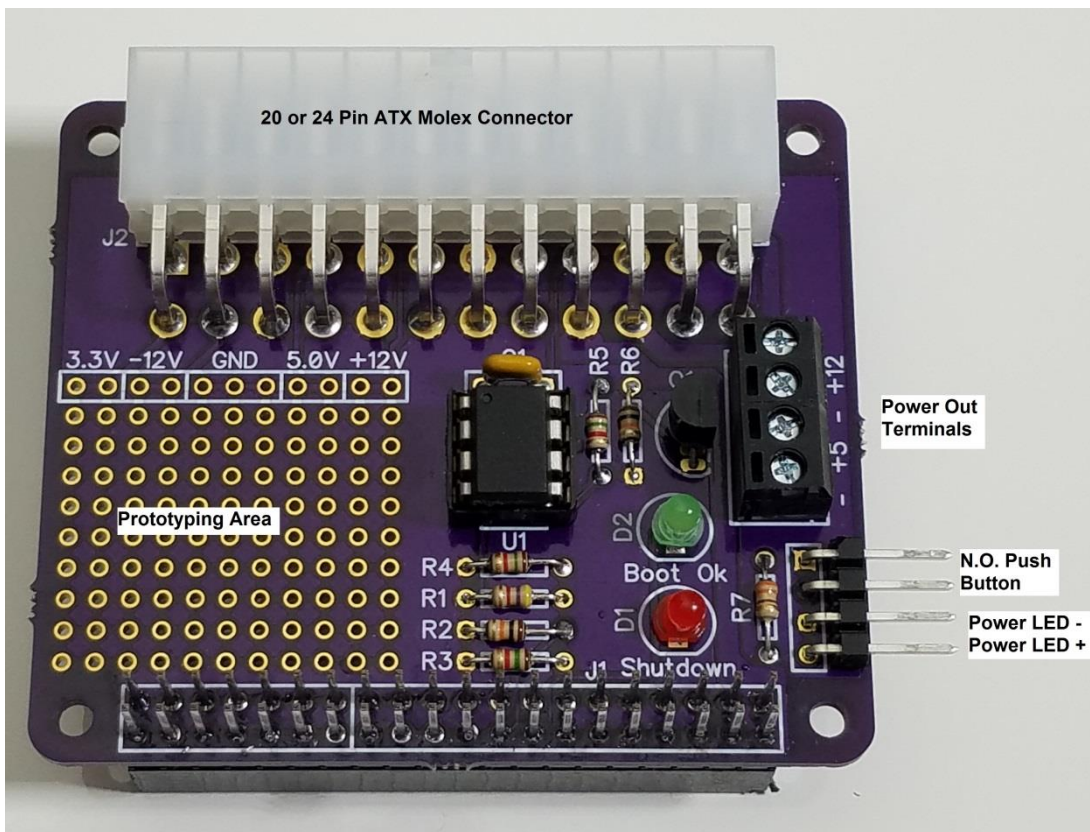

PiRyte Mini ATX PSU

Installation and User Guide.

July 13, 2017

Installing the Mini ATX PSU

The purpose of the Mini ATX PSU is to back power your Raspberry Pi from an ATX style desktop power supply. **Therefore, you must not plug in the Raspberry Pi to its normal 5 VDC USB power supply while the Mini ATX PSU is installed otherwise damage to your Raspberry Pi WILL occur.**

You will install the Mini ATX PSU in this order:

1. Unbox the Raspberry Pi, install its operating system per its instructions.
2. Mount the Mini ATX PSU to the Raspberry Pi.
 - a. Ensure the Raspberry Pi is not connected to its USB power.
 - b. Connect the Mini ATX PSU to the ATX power supply, power LED and switch.
 - c. Turn on power by depressing the power switch and allow the Raspberry Pi to boot up.
The Mini ATX PSU will now be waiting for the 'Boot Ok' signal from the Raspberry Pi.
3. Install the required boot script on to the Raspberry Pi and reboot the machine. When it reboots, it will then send the 'Boot Ok' signal to the Mini ATX PSU telling it to now wait for a power down request.

You will find the necessary boot script at: <https://github.com/tomtibbetts/Mini-ATX-PSU/tree/master/scripts>. This script does two things:

1. Sends a signal to the Mini ATX PSU indicating that the Raspberry Pi booted up properly (turns on the 'Boot Ok' LED).
2. Monitors the 'Shutdown' signal from the Mini ATX PSU. When the 'Shutdown' signal pulses for 0.5 seconds, the script will then initiate a reboot of the Raspberry Pi. If the signal persists longer than 0.6 seconds the script initiates a shutdown of the Raspberry Pi.

Please note that this script requires the use of GPIO 4 (pin 16, 'Boot Ok') and GPIO 5 (pin 18, 'Shutdown'). These pins were selected because they do not conflict with special use pins such as I2C, SPI or UART pins.

To install the script, follow these instructions: (recommended to have Mini ATX PSU mounted on the Pi. Otherwise will automatically shutdown after reboot)

1. `sudo wget https://raw.githubusercontent.com/tomtibbetts/Mini-ATX-PSU/master/scripts/shutdownchecksetup.sh`
2. `sudo bash shutdownchecksetup.sh`
3. `sudo rm shutdownchecksetup.sh`
4. `sudo reboot`

PiRyte Mini ATX PSU Installation and User Guide.

July 13, 2017

ATX Molex Connector

The Mini ATX PSU is designed to work with either 20 pin or 24 pin Molex Mini fit Jr. power supply connectors.

Mating the PiRyte Beret Board to the Raspberry Pi

Your Mini ATX PSU conforms to the Raspberry Pi HAT specification with the exception that it does not have the configuration EEPROM. Additionally, the stacking header require that the spacing between boards to be a bit more than what is specified. Thus, it becomes a Beret and not a HAT.

Initially, the stacking connector J1 will fit into mating connectors very tightly so care must be taken to not damage boards or bend connector pins by using too much force if you wish to separate the boards later on. Therefore, it is recommended to use a rocking approach for both stacking and separating boards. For example, when stacking, gently seat the top board on top of the bottom board ensuring that J1 is properly aligned. Pick one end of the board and gently apply pressure. Release pressure, then move down along the connector and apply pressure again and so on back and forth until the two boards are properly seated. Use the same principals when separating the boards; do a little bit at a time working back and forth along the connectors.

It is recommended to use the threaded standoffs that come with the board to ensure a tight mechanical fit. If this board is the first to be stacked on top of the Raspberry Pi, then use the extra nuts as spacers shown in the image below. This will ensure proper spacing between the Raspberry Pi and the Mini AX PSU. You do not need the extra spacing for additional boards mounted on top of the first board.

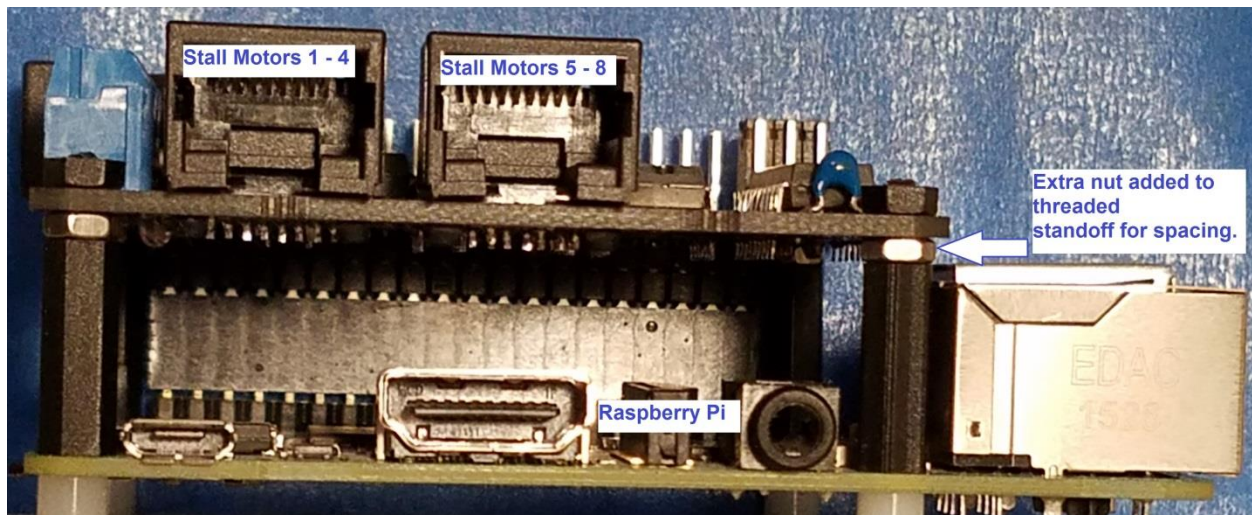

PiRyte Mini ATX PSU

Installation and User Guide.

July 13, 2017

Operating Modes

Program Mode:

By default the Mini ATX PSU is programmed to not remember its power on state in case of power failure. This is to maintain backwards compatibility with older model units. If you wish to have the Mini ATX PSU remember its power state when power is interrupted, then please refer to the programming instructions in the next section.

Power up:

Depressing the power switch when the Raspberry Pi is turned off will initiate the power up sequence. The power indicator LED pulsates slowly until the 'Boot Ok' signal is received from the Raspberry Pi at which time it will go steady on. If the Mini ATX PSU has been programmed to remember its power on state, then it will automatically reboot if the power has been interrupted.

Reboot:

When the Raspberry Pi is running, depressing the power switch for over a half a second will dim the power indicator LED. If you release the switch at this point a short pulse is sent to the Raspberry Pi to initiate a reboot and the power LED will pulsate slowly until the machine has rebooted at which time it will go steady on. If the Mini ATX PSU has been programmed to remember its power on state, then it will automatically reboot if the power has been interrupted.

Shutdown:

When the Raspberry Pi is running, depressing the power switch for over a half a second will dim the power indicator LED. If you hold, then release the power switch for longer than two seconds a long pulse is sent to the Raspberry Pi to initiate a controlled shutdown. The power indicator LED will pulsate slowly until the machine is safe to have power removed at which time the power indicator LED will pulsate quickly for ten seconds before the Mini ATX PSU turns off the Raspberry Pi. If the Mini ATX PSU has been programmed to remember its power on state, then it will remain powered down if power has been interrupted.

Hard Shutdown:

When the Raspberry Pi is running, depressing the power switch for over a half a second will dim the power indicator LED. If you hold the power switch for ten seconds the Mini ATX PSU will turn off power to the Raspberry Pi. This feature is beneficial in the case that the Raspberry Pi has crashed and is not able to be turned off in a controlled manner.

Command line or application forced shutdown:

If the user issues a command to shut down the Raspberry Pi, 'sudo poweroff', the Mini ATX PSU will detect this by listening in on the boot ok line. As the Pi shuts itself down, the boot ok line will go low and the Mini ATX PSU power led will start to pulsate. If the Pi does not reboot itself 'sudo reboot' within

PiRyte Mini ATX PSU

Installation and User Guide.

July 13, 2017

twenty seconds, then the Mini ATX PSU will turn off the desktop power supply. If, within twenty seconds the Pi reboots, then the power led with go steady on and the Mini ATX PSU will operate as before.

Specifications

- Uses inexpensive off the shelf ATX desktop supply. Works with both 20 pin and 24 pin connectors.
- Enables operating system to perform controlled shutdown and reboots to minimize disk file corruption.
- You can program the Mini ATX PSU so that it will remember its “power state”. So, in case of power failure the Mini ATX PSU will automatically turn on the Raspberry Pi when power is restored if it was on previous to the power interruption.
- Back powers the Raspberry Pi with dedicated 5 VDC line.
- Screw terminals break out +12 VDC and +5 VDC for user projects.
- Provides a prototyping area with access to +12 VDC, -12 VDC, +5 VDC, +3.3 VDC, and Ground
- Conforms to the Raspberry Pi Foundation's HAT footprint.
- 40 Pin GPIO stacking header allows use of other HAT conforming boards.
- Comes as a DIY kit to keep costs low.

Programming the Mini ATX PSU Power State Save Mode

1. Start with a fully assembled Mini ATX PSU that is mounted on your Raspberry Pi. Make sure that the ATX desktop power supply is connected and turn off. If the power supply was recently on, you may need to wait a few seconds for its power capacitors to discharge.
2. While pushing and holding the power button connected to J4, turn on the ATX desktop power supply. The power indicator LED of the Mini ATX PSU will pulse once if it's programmed to be stateless (not remember its power state) or pulse twice if it's programmed to be stateful (remember its power state). Release the power button. You are now able to program the Mini ATX PSU.
3. If you do nothing more, then the Mini ATX PSU will rapidly blink the power indicator three times in a row and reset the unit taking it out of programming mode. After five seconds you can turn it in on as you would normally.
4. If, within five seconds, you momentarily push the power button it will toggle its state then pulse the power indicator LED to reflect its new state, once for stateless, twice for stateful.
5. If you're done then go to step three. If you wish to toggle the Mini ATX PSU's state again, then go to step four.

PiRyte Mini ATX PSU

Installation and User Guide.

July 13, 2017

Assembling the PiRyte Mini ATX PSU from a kit

We assume that if you are assembling the Mini ATX PSU Beret from a kit that you are experienced in assembling and soldering circuit boards and their components.

The following order of assembly is recommended:

1. Solder in J1. Make sure that it is “upside down” i.e. with the female portion of the socket under the board so that it can mate with other PiRyte boards and the Raspberry Pi. For best results, make sure the socket is snug against the board and perpendicular to the board.
2. Solder C1.
3. Solder R1 – 4.7K resistor.
4. Solder R3, R4, R5 – 1.5K resistor.
5. Solder R2, R6 – 10K resistor.
6. Solder R7 – 330 ohm resistor.
7. Solder socket for U1. Insert U1 into socket observing proper I.C. alignment.
8. Solder LEDs D1 (red), D2 (green) observing properly alignment of LEDs
9. Solder Q1 observing proper alignment of transistor to match outline. Please note that Q1 may be a kinked or normal lead transistor.
10. Solder J2, J3 and J4.





Note: Resistors R1 and R2 form a voltage divider to level shift the 5 volt signal from the ATTiny processor on the Mini ATX PSU to an acceptable voltage level for the Raspberry Pi. Please double check that the correct resistor value is in the correct place.

PiRyte Mini ATX PSU

Installation and User Guide.

July 13, 2017

Bill of Materials:

Quantity	RefDes	Name	Value	
1	C1	CAP .1uf	100nf	
1	D1	Shutdown	Red	
1	D2	Boot Ok	Green	
1	J4	1 X 4 Header	1 X 4 Header	
1	Q1	2N4401 Kinked	2N4401	
1	R1	RES GENERIC .125W	4.7K	
2	R2, R6	RES GENERIC .125W	10K	
3	R3, R4, R5	RES GENERIC .125W	1.5K	
1	R7	RES GENERIC .125W	330 Ohm	
1	U1	ATTINY85_PDIP	ATtiny85-20PU	
1			8 pin socket	
1	J1	Raspi-40	40 Pin Stacking Header	
1	J2	Molex 39-30-1241	Molex 39-30-1241	
1	J3	4 pin terminal 3.5 MM	4 pin terminal 3.5 MM	

PiRyte Mini ATX PSU Installation and User Guide.

July 13, 2017

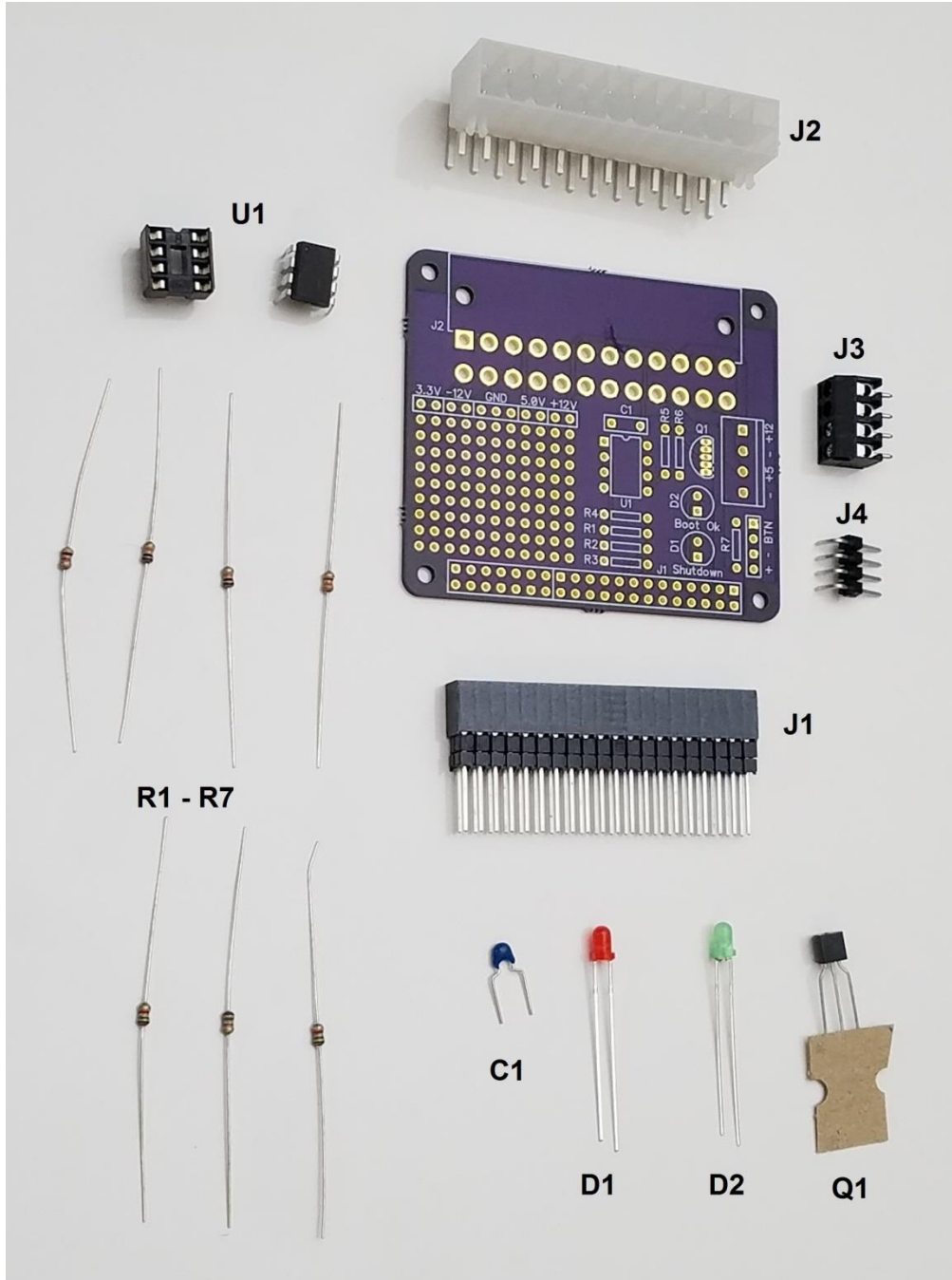

Figure 1: Parts Reference

PiRyte Mini ATX PSU

Installation and User Guide.

July 13, 2017

Warranty

Unassembled kits are warranted for the parts only as home assembly cannot be controlled. However, if you do find yourself with a non-working board and have exhausted all attempts to fix the issue, then the board may be exchanged for a new kit at a discounted price.

Product that has failed for non-warranted reasons may be exchanged for new or equivalent functionality at a discounted price. Please email us using the "Contact Us" page at <http://www.pirYTEboards.com/> for more details.

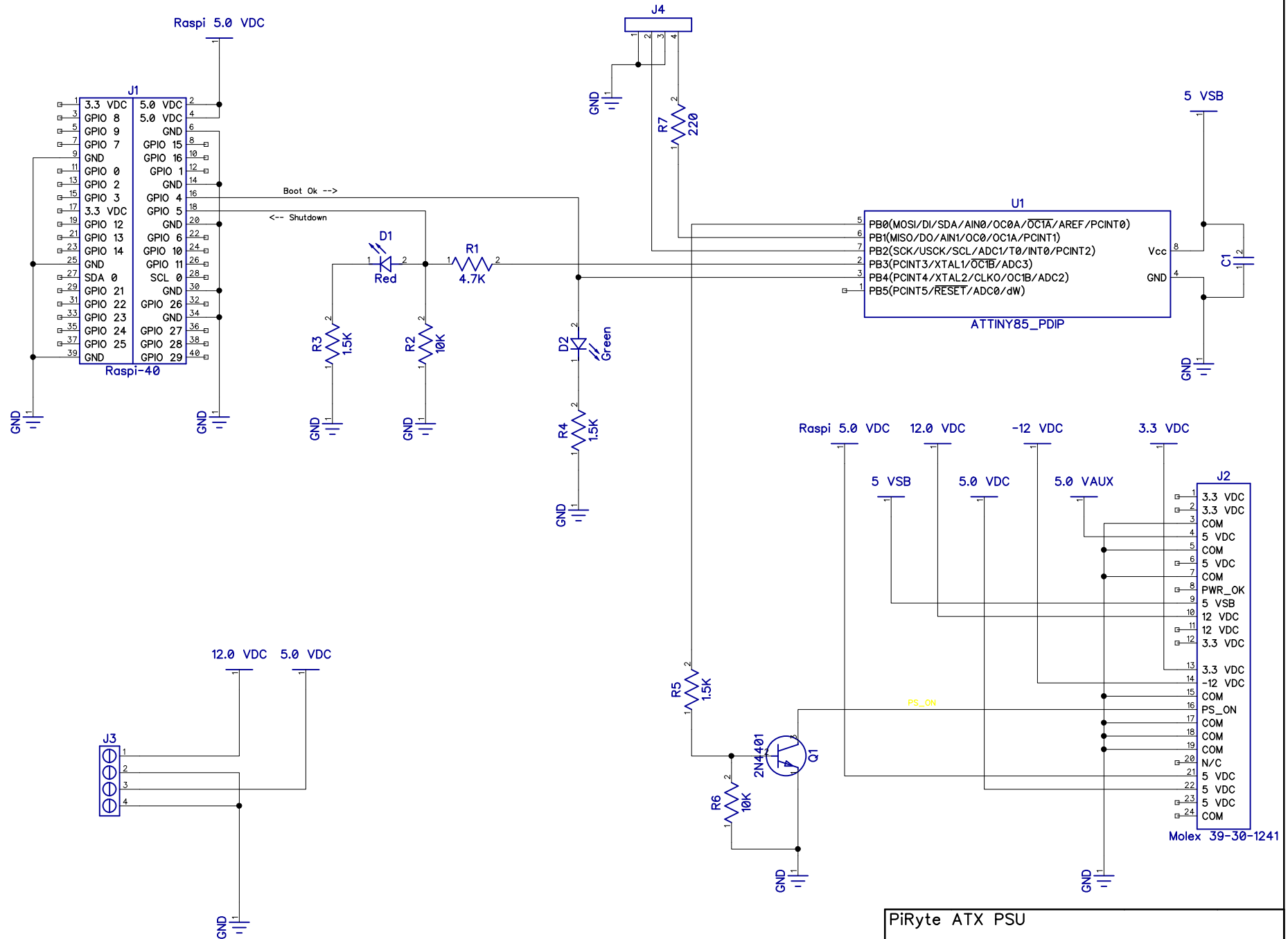

PiRyte ATX PSU		
Size	Number	Rev
	Copyright 2017	1.1.0
	Windhaven Consulting, Inc.	
Date: 6/22/2017	Thomas Tibbetts	
Filename	Sheet 1	