

LS-RDIO0404 Modbus RTU



Contact: Sunny

Whats APP: 86-13826574847

Skype: lensen-tech@outlook.com

Email: sales@lensen-tech.com

Web: www.lensen-tech.com

Add: Xixiang, Baoan, Shenzhen, China

1. LS-RDIO series module general introduction

LS-RDIO Modbus RTU is an industrial controller designed by Lensen Technology. It supports point to point, point to multi-points wireless DI, DO, AI, AO collection and control. This transceiver has the advantage of easy installation, no program required, no communication fee. It is reliable and cost-effective substitution for rail signal cable, slip ring signal wire.

LS-RDIO0404 has 4 inputs 4 relay outputs and 1 RS485(wireless RS485 customized). Power output we have 2 versions, one is 100mW for 1km LOS control distance, and another one is 1W for 3km LOS control distance.

2. Application Field

LS-RDIO series I/O module is widely used in industry automation like factory central data process, pump control, tank level monitoring, Conveyor Control, oil monitoring, mining machinery, environment monitoring equipment, lifting devices, robots control, filling machine, mixing equipment, logistic line, AGV etc.

3. About Item Name

Introduction to Lensen IO series Modbus RTU Module Naming regulation

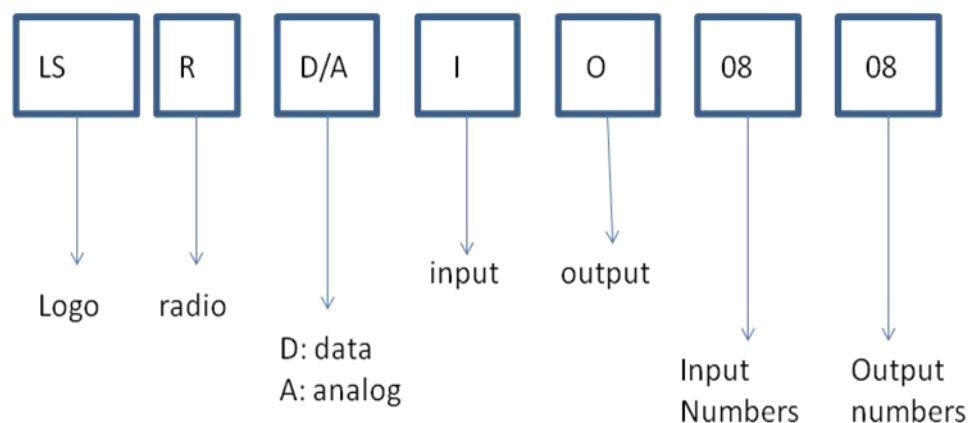

For example:

LS-RDIO0808 means Lensen 8DI 8DO Module

LS-RDIO0404 means Lensen 4DI 4DO Module

LS-RAIO04 means Lensen 4AI module

4. Parameter of RDIO0404

Parameter	
Power output:	1W or 100mW version
Power supply:	9V-30V (usually choose 24V DC or 12V DC)
Control distance:	3km or (1km version)
Baud rate:	2400bps default
Receiving sensibility:	-123dBm@1200bps, -118dbm(9600bps)
Networking	
Networking:	Point to point and point to multipoints
Port Description	
Input:	4 digital active inputs(passive customize)
Output:	4 relay outputs, contact max load AC250V/5A, DC30V/5A (active outputs 0-5V customize)
Communication port	RS485 (wireless RS485 customize)
Current	
Transmit current:	<600mA (or 100mA version)
Receiving current:	<50mA (or 20mA version)
General	
Frequency:	433MHz, 450, 470 or other band
Channel No:	16 channels,can change via DIP switch
Physical Properties	
Dimension:	115×90×40(mm)
Antenna Connector:	SMA, vehicle antenna with 1.5m cable
Temperature:	35℃~+75℃(industrial)
Mounting method:	Standard 3.5 inch industrial guild rail

5. How to use

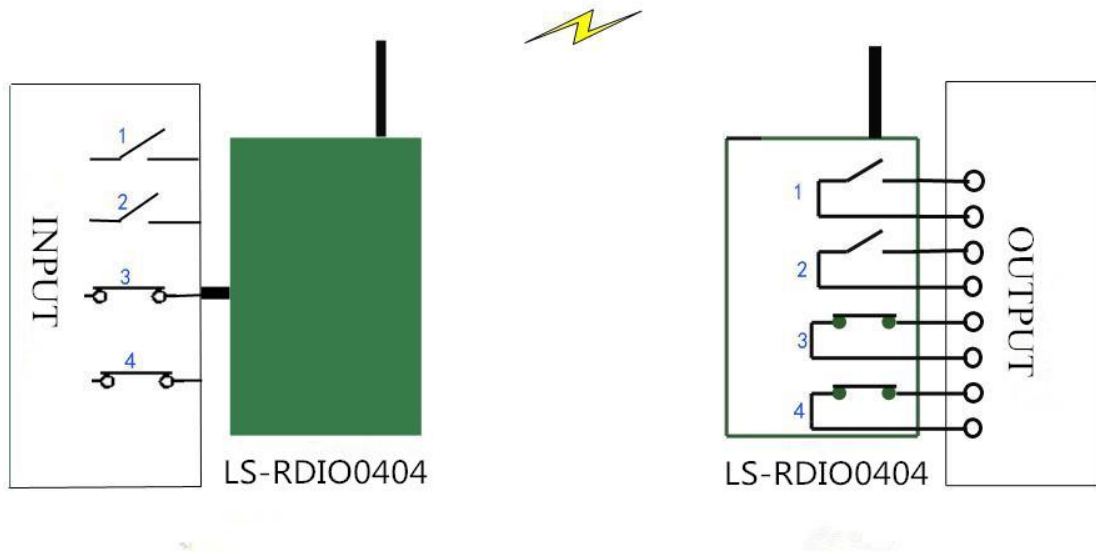

6. LS-RDIO series I/O control application example

1) Point to point control

LS-RDIO series point to point control application example

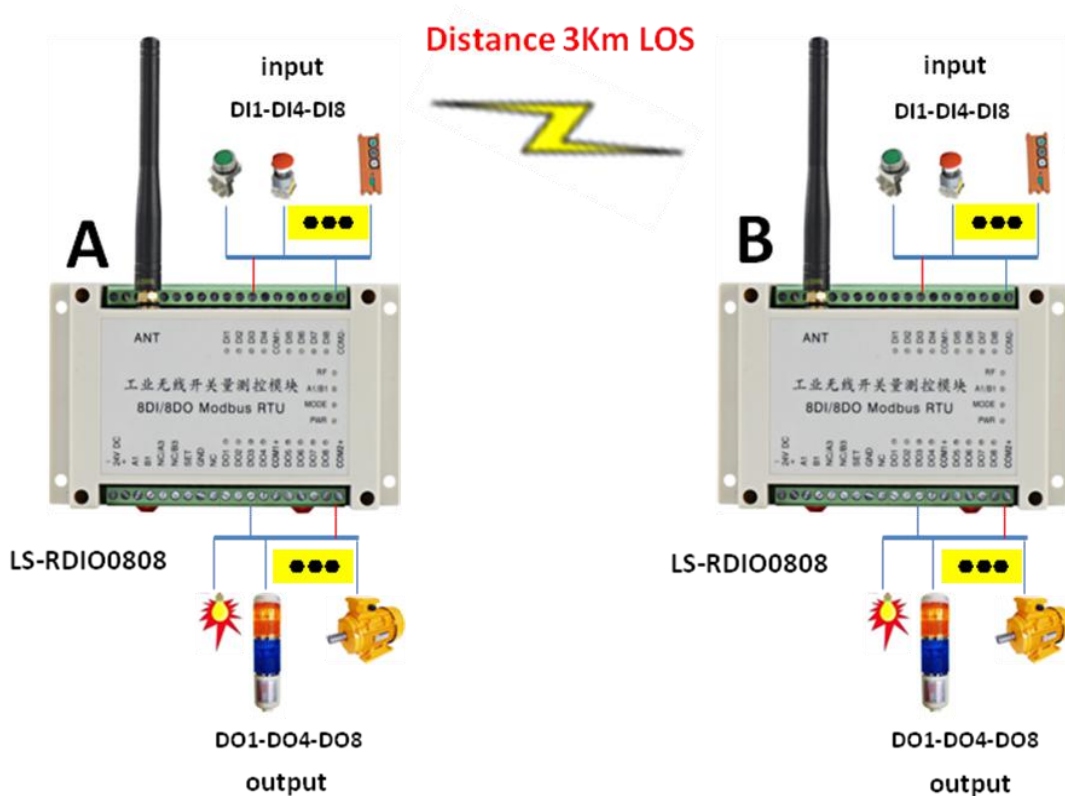

Remarks:

Module A	Module B	Input and Output Correspondence
A (DI1-DI8)	B (DO1-DO8)	DI1-DI8 of A to control DO1-DO8 of B respectively
A (DO1-DO8)	B (DI1-DI8)	DO1-DO8 of A is controlled by DI1-DI8 of B respectively
Notes: A and B should use the same channel		

2) One master to control 2 slaves

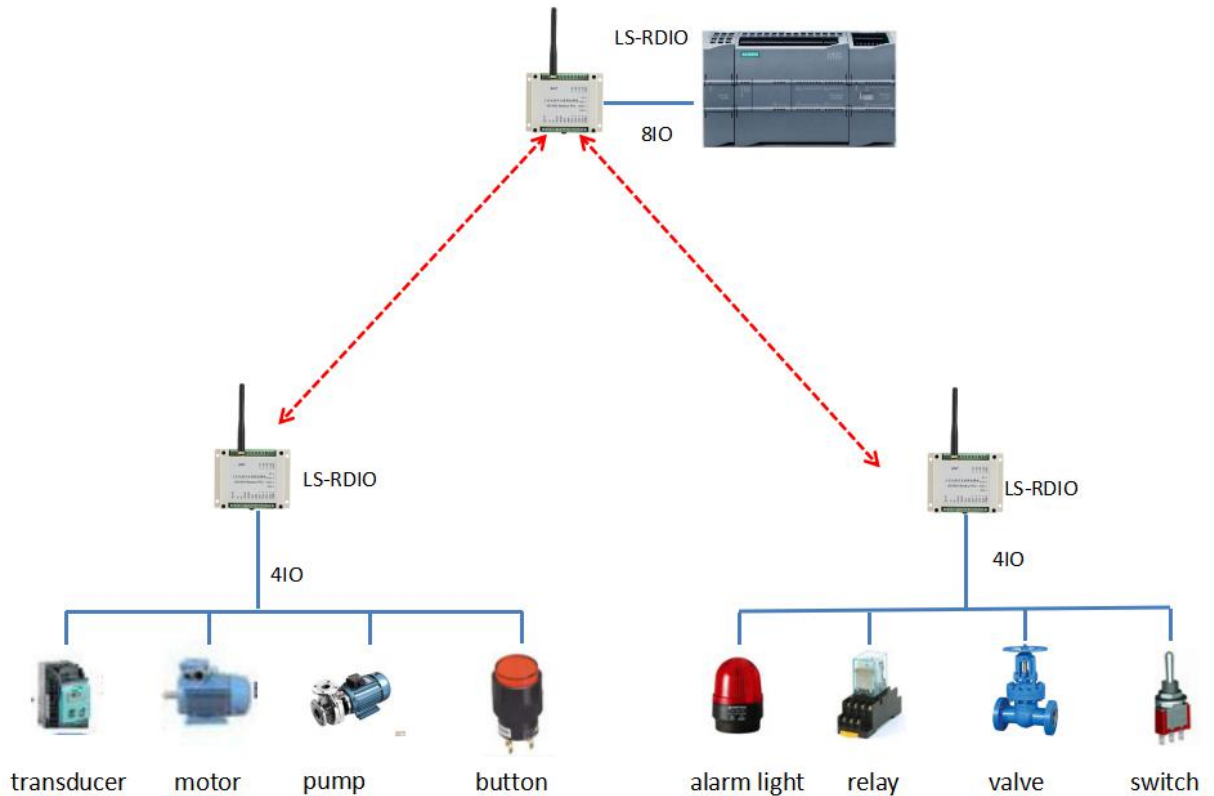

Remarks:

Master Module	Slave Module	Input and Output Correspondence
A (DI1-DI4)	B1 (DO1-DO4)	DI1-DI4 of A control DO1-DO4 of B1 respectively
A (DI5-DI8)	B2 (DO1-DO4)	DI5-DI8 of A control DO1-DO4 of B2 respectively
A (DO1-DO4)	B1 (DI1-DI4)	DO1-DO4 of A is controlled by DI1-DI4 of B1
A (DO5-DO8)	B2 (DI1-DI4)	DO5-DO8 of A is controlled by DI1-DI4 of B2
Notes: A and B should use the same channel		

3) One master to control 4 slaves

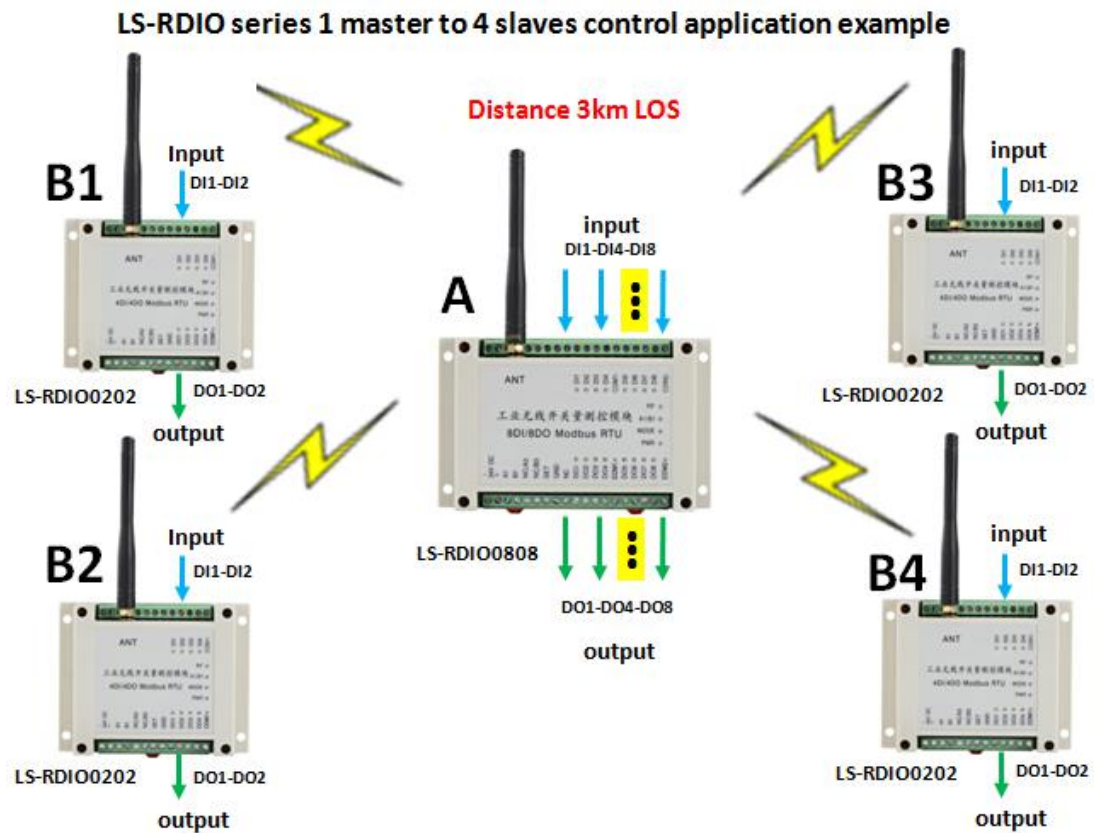

Remarks:

Master	Slave	Input and Output Correspondence
A (DI1-DI2)	B1 (DO1-DO2)	DI1-DI2 of A control DO1-DO2 of B1
A (DI3-DI4)	B2 (DO1-DO2)	DI3-DI4 of A control DO1-DO2 of B2
A (DI5-DI6)	B3 (DO1-DO2)	DI5-DI6 of A control DO1-DO2 of B3
A (DI7-DI8)	B4 (DO1-DO2)	DI7-DI8 of A control DO1-DO2 of B4
A (DO1-DO2)	B1 (DI1-DI2)	DO1-DO2 of A controlled by DI1-DI2 of B
A (DO3-DO4)	B2 (DI1-DI2)	DO3-DO4 of A controlled by DI1-DI2 of B2
A (DO5-DO6)	B3 (DI1-DI2)	DO5-DO6 of A controlled by DI1-DI2 of B3
A (DO7-DO8)	B4 (DI1-DI2)	DO7-DO8 of A controlled by DI1-DI2 of B4

Notes: A and B should use the same channel

4) One master to 8 slaves

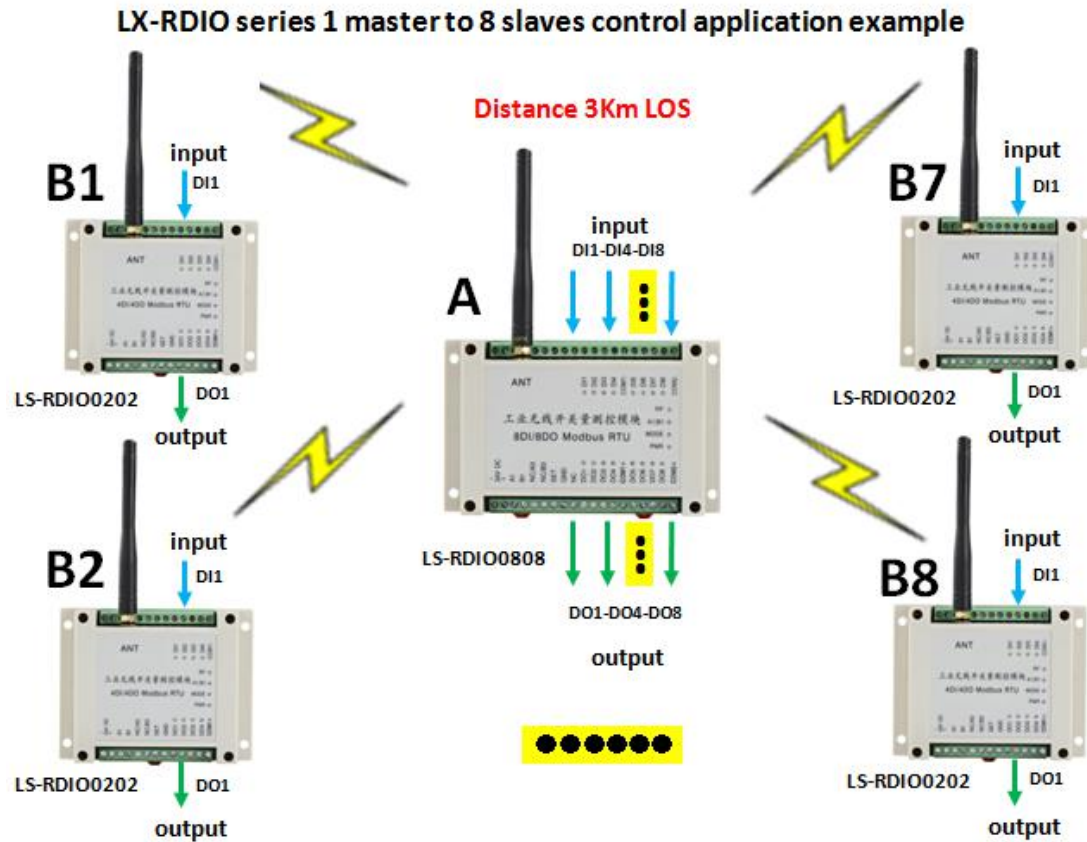

Remarks:

Master	Salve	Input and control correspondence
A (DI1)	B1 (DO1)	DI1 of A control DO1 of B1
A (DI2)	B2 (DO1)	DI2 of A control DO1 of B1
A (DI3)	B3 (DO1)	DI3 of A control DO1 of B1
A (DI4)	B4 (DO1)	DI4of A control DO1 of B1
A (DI5)	B5 (DO1)	DI5 of A control DO1 of B1
A (DI6)	B6 (DO1)	DI6 of A control DO1 of B1
A (DI7)	B7 (DO1)	DI7 of A control DO1 of B1
A (DI8)	B8 (DO1)	DI8 of A control DO1 of B1
A (DO1)	B1 (DI1)	DO1 of A is controlled by DI1 of B1
A(DO8)	B8(DI1)	DO8 of A is controlled by DI1 of B8

Note: module A and B should use the same channel;

5) To communicate with PC/PLC

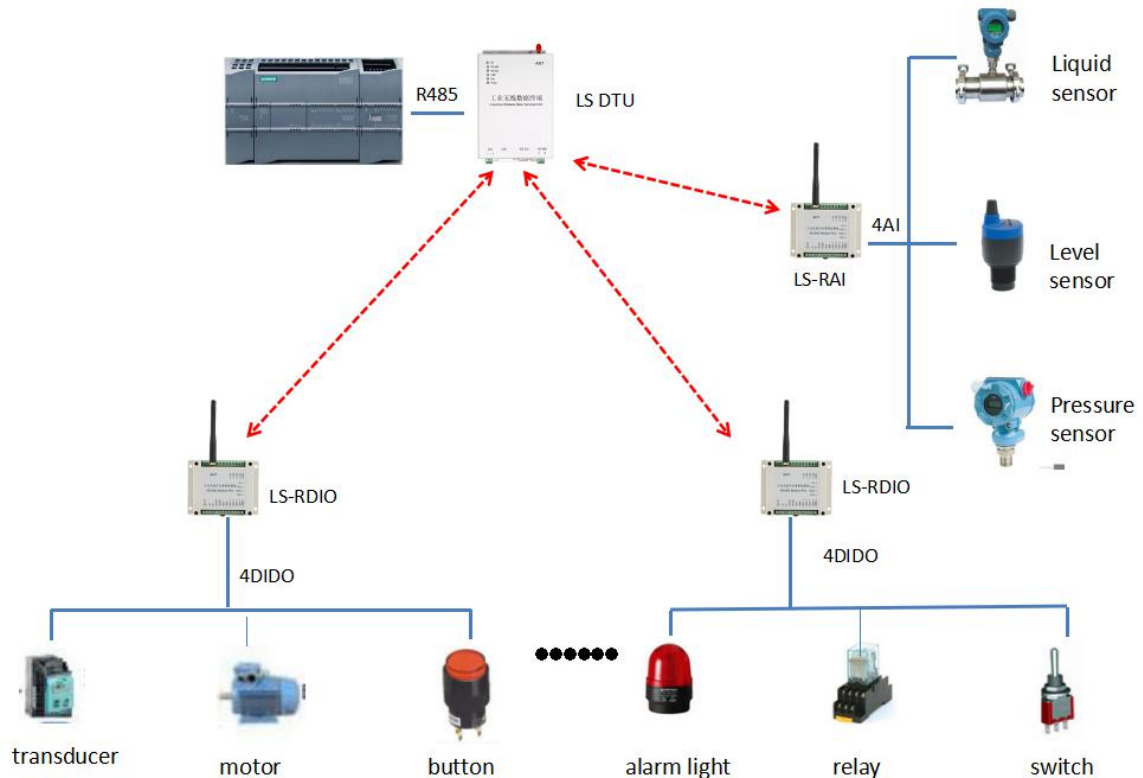

7. Modbus RTU communication and value calculation

A. Register types:

Register types	Read command	Write command (Control command)	Power off	Function
coil register	0x01	Input --not support Output-support	Not keep	Can read input value
Hold register	0x03			

1) Coil register:

Input: it is not convenient to read 8 I/O at one time. In order to control each I/O correspondingly, we defined coil register. The register address is 0x0000-0x0007.

Output: it is not convenient to control 8 I/O at one time. In order to control each I/O correspondingly, we defined coil register whose address is 0x0020-0x0028.

Note: The coil is not extra resource, just a method for register addressing---addressing by bit.

2) Holding register:

a. value of input channels: 0x0000

Note: addressing by bit means we only use the first 8 bits; bit0 to bit7 corresponds with I / O1 to I / O8;

b. feedback and value of output channels: 0x0040

Note: addressing by bit means bit 0 corresponds with 1/O1, bit 7 corresponds with 1/O8, bit 8-bit 15 corresponding value we write 0.

3) Reading method:

Coil register: Directly read the responding register. 1 means OFF, 0 means ON.

Holding register: Can read all 8 inputs state one time. We only use bit0-bit7 of this 16-bit register; each bit represents the state of an input.

4) Control methods:

a. Use the coil--- directly writes the corresponding coil register you can control corresponding output.

b. Use the holding register--- eight outputs share 1 holding register, so you can manage each bit separately to control the responding output.

B. About register control







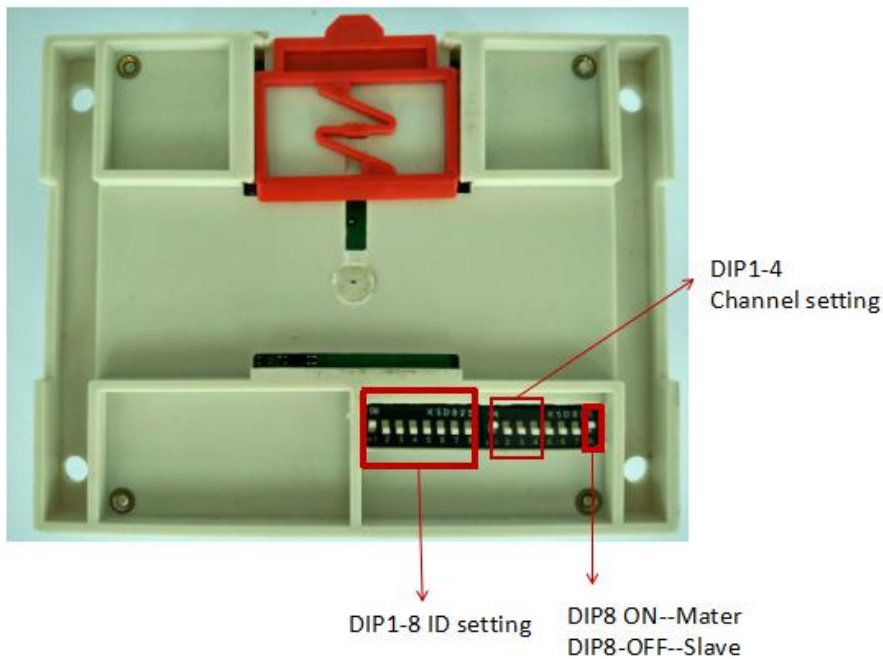

Channel	IC			Read/ write	Function code	Products apply
	IC type	PLC ID	Modbus ID			
DI1	Coil reg.	1	0	read	01	RDIO0202 RDIO0404 RDIO0808
	Holding reg.	40001.0	0.0	read	03	
DI2	Coil reg.	2	1	read	01	RDIO0808
	Holding reg.	40001.1	0.1	read	03	
DI3	Coil reg.	3	2	read	01	RDIO0404 RDIO0808
	Holding reg.	40001.2	0.2	read	03	
DI4	Coil reg.	4	3	read	01	RDIO0808
	Holding reg.	40001.3	0.3	read	03	
DI5	Coil reg.	5	4	read	01	RDIO0808
	Holding reg.	40001.4	0.4	read	03	
DI6	Coil reg.	6	5	read	01	RDIO0808
	Holding reg.	40001.5	0.5	read	03	
DI7	Coil reg.	7	6	read	01	RDIO0808
	Holding reg.	40001.6	0.6	read	03	
DI8	Coil reg.	8	7	read	01	RDIO0808
	Holding reg.	40001.7	0.7	read	03	
DO1	Coil reg.	33	32	Read/ write	01/05	RDIO0202 RDIO0404 RDIO0808
	Holding reg.	40065.0	64.0	Read/ write	03/06	
DO2	Coil reg.	34	33	Read/ write	01/05	RDIO0808
	Holding reg.	40065.1	64.1	Read/ write	03/06	
DO3	Coil reg.	35	34	Read/ write	01/05	RDIO0404 RDIO0808
	Holding reg.	40065.2	64.2	Read/ write	03/06	

DO4	Coil reg.	36	35	Read/ write	01/05	RDIO0808
	Holding reg.	40065.3	64.3	Read/ write	03/06	
DO5	Coil reg.	37	36	Read/ write	01/05	
	Holding reg.	40065.4	64.4	Read/ write	03/06	
DO6	Coil reg.	38	37	Read/ write	01/05	
	Holding reg.	40065.5	64.5	Read/ write	03/06	
DO7	Coil reg.	39	38	Read/ write	01/05	
	Holding reg.	40065.6	64.6	Read/ write	03/06	
DO8	Coil reg.	40	39	Read/ write	01/05	
	Holding reg.	40065.7	64.7	Read/ write	03/06	

8. DIP Setting:



1) Outer(right side)DIP 1-4 are used for channel setting. Please check the following definition













Channel No.	DIP Setting	Channel No.	DIP Setting	Channel No.	DIP setting	Channel No.	DIP setting
1	 1234	2	 1234	3	 1234	4	 1234
5	 1234	6	 1234	7	 1234	8	 1234



Above sample in picture is CH1

2) Outer(right side)DIP 5-8 are used for mode setting. Please check the following definition

DIP	Status	Function	Remarks
5	OFF	With feedback	
	ON	No feedback mode	remote side DI, this side only DO
6、7	OFF、OFF	1 to 1 control	Master set ID to X, Slave module's ID set to X (ie. master ID1, slave ID1. remember set ID the same)
6、7	ON、OFF	1 to 2 slaves control	Master set to ID1, 2 slave modules' ID set to 1 and 2 respectively
6、7	OFF、ON	1 to 4 slaves control	Master set to ID 1, 4 slave modules' ID set to 1, 2, 3 and 4 respectively
6、7	ON、ON	1 to 8 slave control	Master set to ID 1, 8 slaves' ID set to 1, 2, 3, 4, 5, 6, 7 and 8 respectively
8	OFF	Slave mode	
	ON	Master mode	

3) Interior(left side) DIP 1-8 are used for module's ID setting (also Modbus slaves' ID.), for example

ID	DIP setting	ID	DIP setting	ID	DIP setting
1		2		3	
4		5		6	
7		8		9	
10		11		12	

13		14		15	
DIP for slaves with ID 16-254, please refer the above regulation to set					

Note: Above sample in picture is ID1

9. How to connect LS-RDIO series Modbus RTU

LS-RDIO series block terminal description

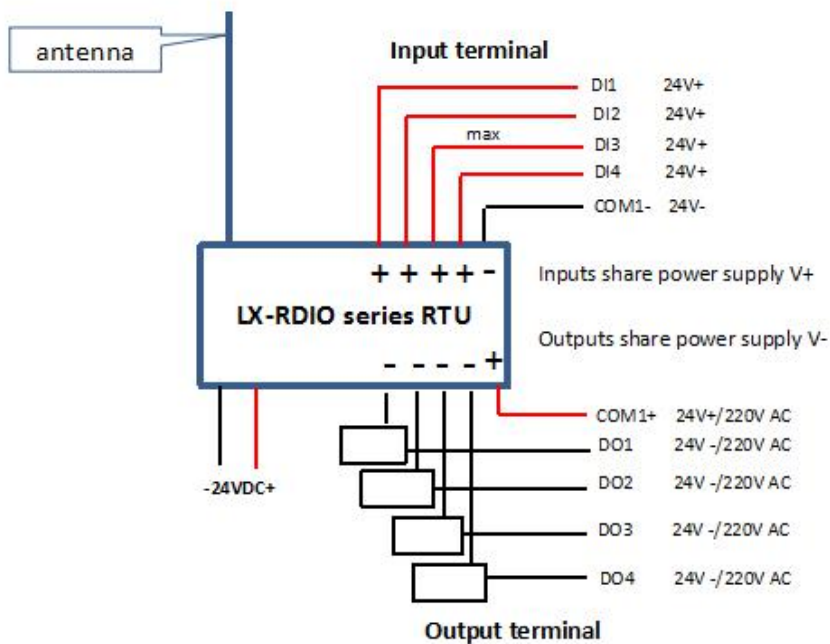

10. LS-RDIO series how to choose proper item:

Item No.	Distance	I/O numbers	Power supply	Interface
LS-RDIO 0202	600m、3000m	2DI、2DO	9-36V DC	RS-485
LS-RDIO 0404		4DI、4DO		
LS-RDIO 0808		8DI、8DO		