

# QR10x General-Purpose Pocket Programmable Resistance Substitution Box

## Specification & User's Manual

(Since Kickstarter Campaign Batch)





As a candidate for replacing/upgrading conventional resistance decade box, QR10 has as good as, if not better than, the top class of the latter on the accuracy, range, resolution/step, repeatability, and temperature coefficient. It provides a "better operation experience" on the user interface, much higher rated power, and much smaller dimensions. More importantly, it's just a "programmable" resistance substitution box the way it should be – the user can either set desired output value by an integrated keypad or remotely control it via a USB-Serial COM port.

The COM port mentioned makes it suitable for advanced applications such as data acquisition and auto-tests, for example, sensor simulation and sensor auto-calibration.

what is more, thanks to the design solution and approach chosen, QR10 can use standard key components to improve quality and reduce cost; And, allowing user calibration makes it easy for maintenance and keeps long-term accuracy as well

### Key Features

- "True" resistance generated by relay-resistor network
- Easy-to-use keyboard and useful OLED display
- USB to serial communication interface, support private AT instruction set
- Initial high accuracy (>500Ω):  
±0.05%(class T);  
±0.02% (class B)
- NO RESIDUAL RESISTANCE
- Wide range:  
1Ω -630kΩ (0.1Ω/0.07Ω steps)  
1Ω -1.2MΩ (0.125Ω steps)  
1Ω -8.4MΩ (1Ω step)
- Maximum power rating up to 2.0W
- Safety output limit(user definable)
- Latched output with ZERO power consumption
- Allow user field calibration (after calibration accuracy can follow reference meter's for grade B)
- Rechargeable Li-PO battery
- Portable with small dimensions and solid metal housing:  
5.5cm (OD)× 5.5cm (H) or 7.0cm (H)

### Applications

- Traditional resistance boxes replacement
- Industrial automation testing
- Resistive sensor simulation
- Resistive sensor calibration
- Online debugging of circuits
- .....

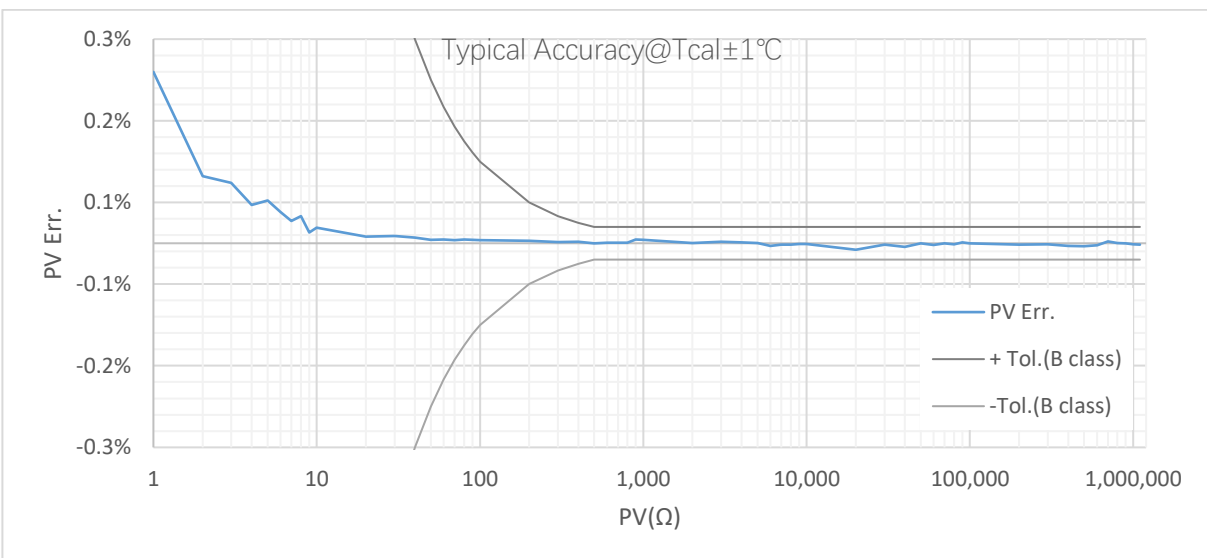

## Abbreviation/terminology checklist

SP	Set Point (by user)
PV	Process Value, or output value/return value (by the device)
TC or TCR	Temperature Coefficient of Resistance
Tcal	Calibration Temperature
$\Delta T$	Temperature difference, specifically refers to the difference between the test ambient temperature and the calibration temperature
NPLC	Number of Power Line Cycles
EMF	Thermal Electromotive Force
(On OLED)K	k $\Omega$
(On OLED)M	M $\Omega$
MaxU or (On OLED)U<	The highest allowable voltage across the output
(On OLED) F	The factory calibration data is activated
(On OLED) U	The user calibration data is activated
(On OLED)R>	Minimum output limit value
(On OLED)TS	Internal Temperature Sensor
(On OLED)VB	Voltage of Battery
(On OLED)STP	Step
(On OLED)TOL	Tolerance
(On OLED)RGE	Output Range
(On OLED)PWR	Rated Power
(On OLED)OTR	Operating Temperature Range
(On OLED)C/T	Calibration Temperature
(On OLED)H/W	Hardware version
(On OLED)F/W	Firmware version
(On OLED)S/N	Serial Number
(On OLED)PRD	Date of Production

## Order code <sup>1,2,3</sup>

Valid Order code	QR100	<input type="checkbox"/>	-	<input type="checkbox"/> <input type="checkbox"/> - <input type="checkbox"/> <input type="checkbox"/>
	A	: $\pm 0.01\%$ , TC < 25 ppm		<b>1K-R1</b> : 1 $\Omega$ ~ 870 $\Omega$ , 0.1 $\Omega$ /0.07 $\Omega$ steps <sup>4</sup>
	B	: $\pm 0.02\%$ , TC < 25 ppm		<b>2K-RX</b> : 1 $\Omega$ ~ 1.7k $\Omega$ , 0.125 $\Omega$ steps
	T	: $\pm 0.05\%$ , TC < 50 ppm		<b>AK-1R</b> : 1 $\Omega$ ~ 11.5k $\Omega$ , 1 $\Omega$ steps
	QR101	<input type="checkbox"/>	-	<input type="checkbox"/> <input type="checkbox"/> - <input type="checkbox"/> <input type="checkbox"/>
	A	: $\pm 0.01\%$ , TC < 25 ppm		<b>1M-R1</b> : 1 $\Omega$ ~ 630k $\Omega$ , 0.1 $\Omega$ /0.07 $\Omega$ steps <sup>4</sup>
B	: $\pm 0.02\%$ , TC < 25 ppm		<b>2M-RX</b> : 1 $\Omega$ ~ 1.2M $\Omega$ , 0.125 $\Omega$ steps	
T	: $\pm 0.05\%$ , TC < 50 ppm		<b>AM-1R</b> <sup>5</sup> : 1 $\Omega$ ~ 8.4M $\Omega$ , 1 $\Omega$ steps	

- 1 For detailed definitions such as accuracy, please refer to the specification below.
- 2 Accurate output ranges vary from machine to machine and batch to batch. In general, the difference in the maximum output is within 5% of the given value in the above table, and the minimum output value is about 1.0  $\Omega$ .
- 3 Class A production is suspended. Users can self-calibrate Class B or T using a high-grade reference meter to achieve higher accuracy.
- 4 For 0.1 $\Omega$  stepping models, subsequent manufacturing will upgrade to 0.07 $\Omega$  steps.
- 5 Production of QR101B-AM-1R is suspended and QR101T-AM-1R is available.

Specification (The yellow highlighted sections are the main additions or modifications to the datasheet)

Key parameters	QR100/101			Remark
<b>Output</b>				
	Class	T @ $T_{cal} \pm 5^\circ\text{C}$	B @ $T_{cal} \pm 3^\circ\text{C}$	1. Under no load, operation $< 1 \times 10^6$ times 2. Calculated by PV
	Range			
Initial accuracy	< 500 $\Omega$	$\pm 0.25 \Omega$	$\pm 0.1 \Omega$	
	500 $\Omega$ ~ 2 M $\Omega$	$\pm 0.05\%$	$\pm 0.02\%$	
	>2 M $\Omega$	$\pm 0.1 \%$	$\pm 0.05 \%$	
Nominal stepping	0.1 $\Omega$ / 0.07 $\Omega$ , 0.125 $\Omega$ or 1.0 $\Omega$			
Difference between SP and PV	< 1 nominal step, the typical value is 0.3 nominal step			
Overall TC (>100 $\Omega$ )	Class T: <50 ppm Class B: <25 ppm			
Rated power	1.0~2.0 W (up to 200 Vdc), depending on the output resistance			Please refer to the COM port return data
Short-cut and open-circuit	Not supported			
Relay type	Bistable signal relays (electromagnetic relays)			
Relay reliability	Underrated load*: $> 1 \times 10^{15}$ times No load: $> 1 \times 10^{17}$ times			*Rated load of relay: 1A@30 VDC or 0.3A@125 VAC
Minimum contact rating for relays / Minimum load for the output	10uA @ 10 mVDC			This value may vary depending on the frequency of operation and the usage environment. Use below this value may cause malfunction
Relay group switching time	QR100: < 55 ms QR101: < 95 ms			
Relay group switching mode	In natural mode, the output may be open or short-circuited during the switching			
Recommended max operating frequency	1Hz			
Max operating frequency	5Hz			Under the condition of small power applied to the output
Output terminals	Terminal posts, 2-wire			
<b>Communication interface</b>				
Power supply (and for recharging)	5V $\pm$ 0.25V, 100mA min.			
Max peak current	About 50mA@5V, < 0.1s			Happens only when relays are switching
Power supply connector	Via USB type-C			
Communication bus	USB to serial port (COM)			

## Specification(continued)

Driver IC	WCH CH340	
Baud rate & settings	115,200 bps, 8 data bits, no parity, and 1 stop bit	
Protocol	Private AT command set (see below)	
<b>Other features</b>		
Keypad	Mechanical keys with silicone rubber caps	non-waterproof
Display	0.54" OLED, monochrome	
Display resolution	SP: 0.1 $\Omega$ or 6 digits PV: 1 m $\Omega$ or 6 digits	
Internal temperature measurement	Yes, the typical accuracy is $\pm 0.1^{\circ}\text{C}$	
User field calibration	Yes. Guarantee that the output accuracy after calibration is not lower than the initial accuracy; Guarantee that for B/A class the output accuracy can theoretically follow the reference meter accuracy ( $\pm 0.003\%$ of the reading $\pm 10\text{m}\Omega$ ) in a short period after calibration*	* The actual results are related to the reference meter's accuracy/ linearity, the correctness of calibration operations, and device hardware stability.
Scanning output	Yes	Refer to keypad operation
Safety output limit	Yes, user-defined	
Power saving	Turn off display after 1 min of inactivity; Shut down after 1 h of inactivity if without USB cable connected	
<b>Others</b>		
Battery type	Rechargeable Li-polymer. 500+ charge/discharge cycles	
Battery life	About 12h@ 1Hz operation	
Battery charging time	3 hours	
Battery Shelf life	10 month. Re-charge the battery every 8 months is recommended	
Operating temperature	$-10^{\circ}\text{C} \sim 40^{\circ}\text{C}$	
Relative humidity	10 % to 95 % non-condensing	
Storage temperature	$-20^{\circ}\text{C}$ to $75^{\circ}\text{C}$	
Housing material	Brass (cup), Dioxide aluminum alloy (lid)	
Dimensions	QR100: 5.5 cm (OD) $\times$ 5.5 cm (H) QR101: 5.5 cm (OD) $\times$ 7.0 cm (H)	
Weight	QR100: about 215g QR101: about 252g	
Accessories	M4 banana plug cable* $\times 2$ ; Class B provides a factory calibration certificate (electronic version, see Appendix 1)	*25m $\Omega$ per single
Warranty	1 year	Indoor use only

## Typical characteristics

Unless otherwise noted, all tests are based on test data of Class B samples at room temperature, and the accuracy in the charts is the relative accuracy based on the reading of the reference meter.

The uncertainty of the reference meter used is better than  $\pm 0.013\%$  in the  $<1M\Omega$  range. The uncertainty of the reference meter should be considered when deriving the absolute accuracy.

Definition:  $\Delta T = \text{ambient temperature at test} - T_{cal}$

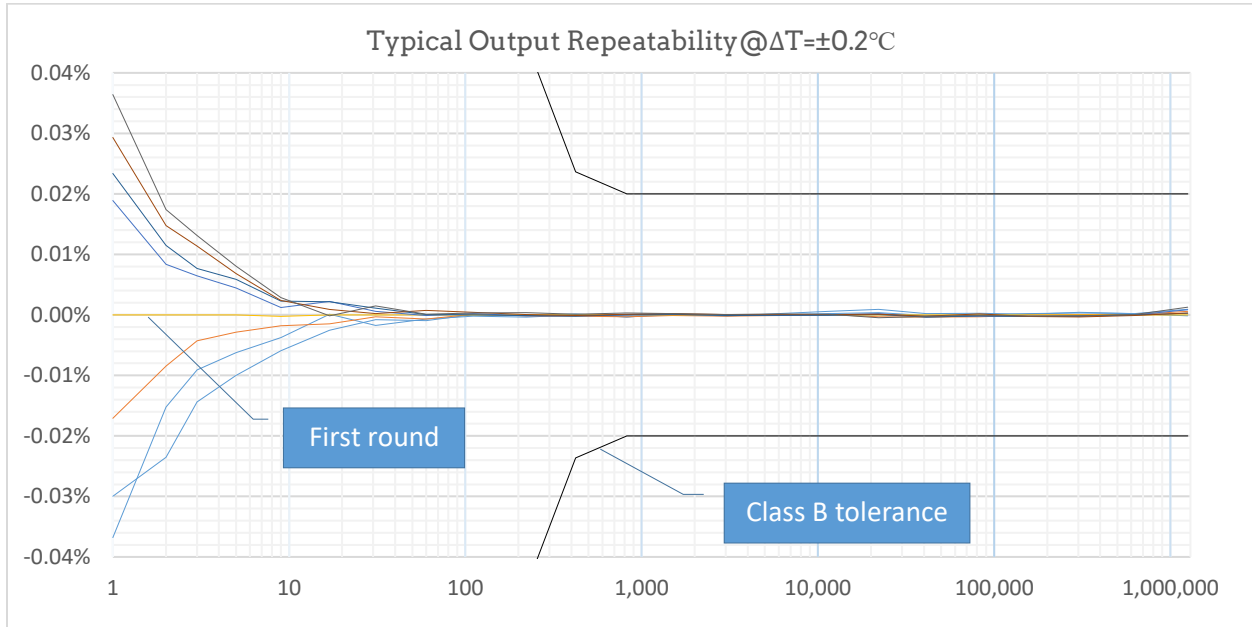

Above: Repeatability is based on the results of 8 consecutive rounds of testing of the same sample at room temperature (fluctuation range of about  $\pm 0.2^\circ\text{C}$ ). Errors are based on comparison with the results of the first round.

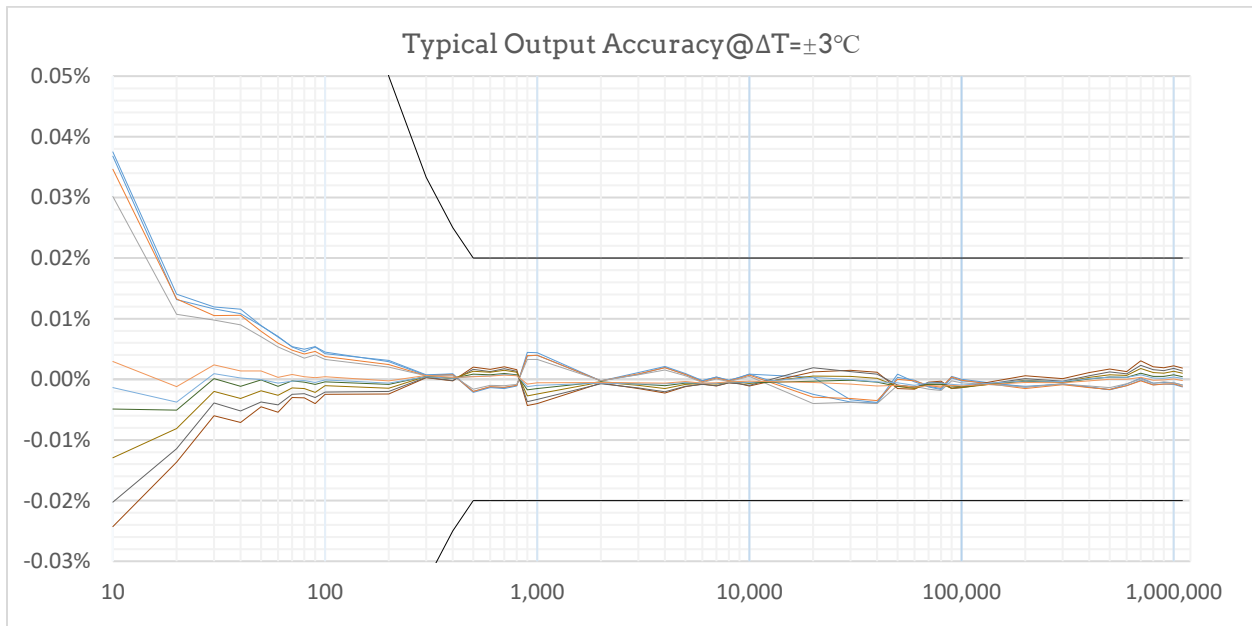

Above: Accuracy is based on 10 consecutive rounds of testing of the same sample in a thermostat (temperature variation range:  $T_{cal}-3^\circ\text{C}$  to  $T_{cal}+3^\circ\text{C}$ ). Errors are based on direct comparisons with reference meter readings and do not include the uncertainty of the reference meter itself.

## Typical characteristics (continued)

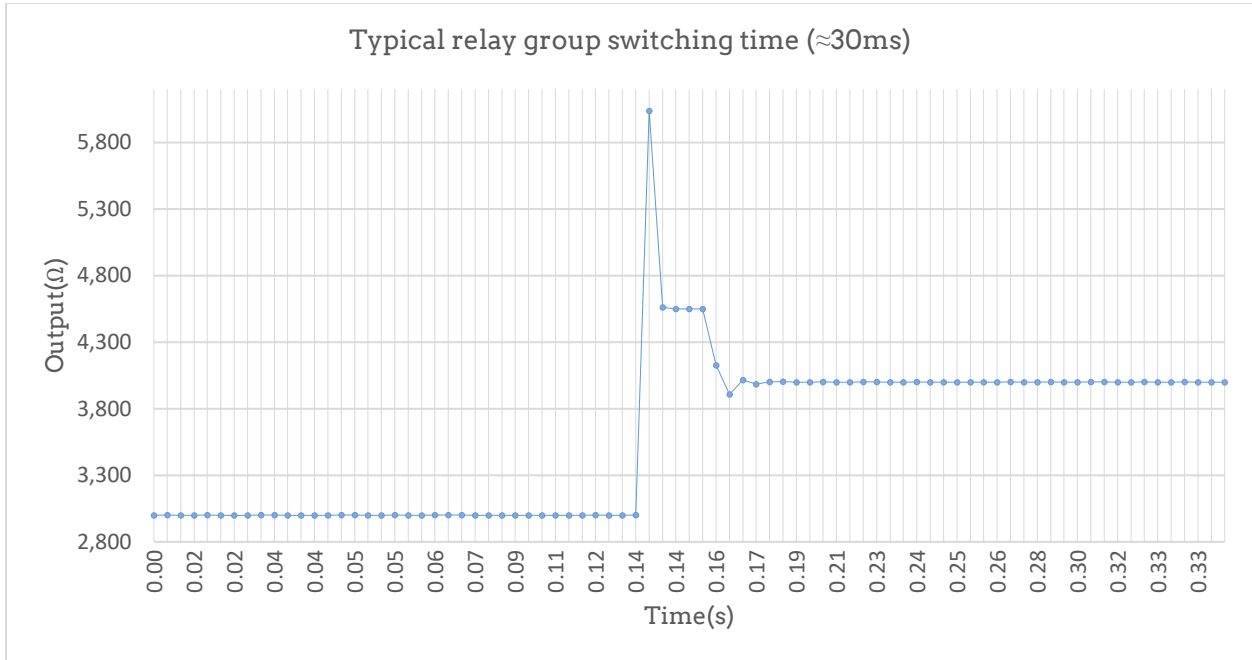

Above: Typical relay group switching time. The example is monitoring the process of switching from  $3\text{k}\Omega$  to  $4\text{k}\Omega$ , with the measurement mode 2-wire and the configuration  $\text{NPLC}=0.05$ .

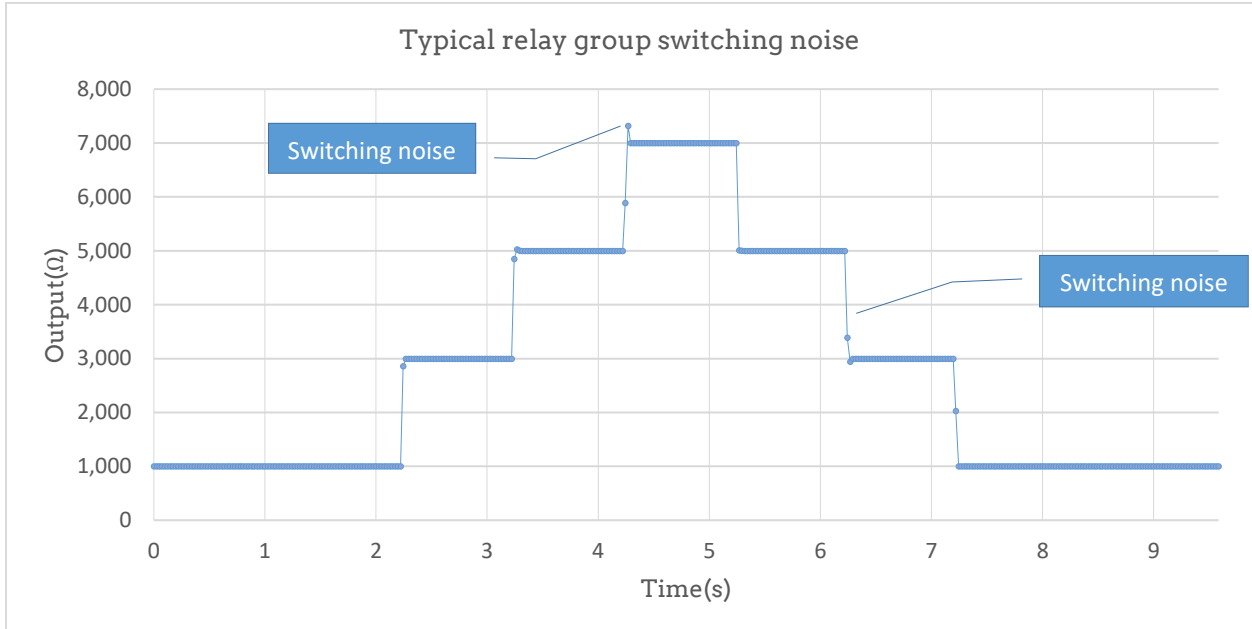

Above: The "output resistance noise" generated by relay switching occurs on the rising or falling edge, and is more obvious during some resistance switching. It should be noted that the relay switching algorithm of the QR10 is not specifically optimized, so in some cases, the output may be open or shorted for a short period (ms level).

## Typical characteristics (continued)

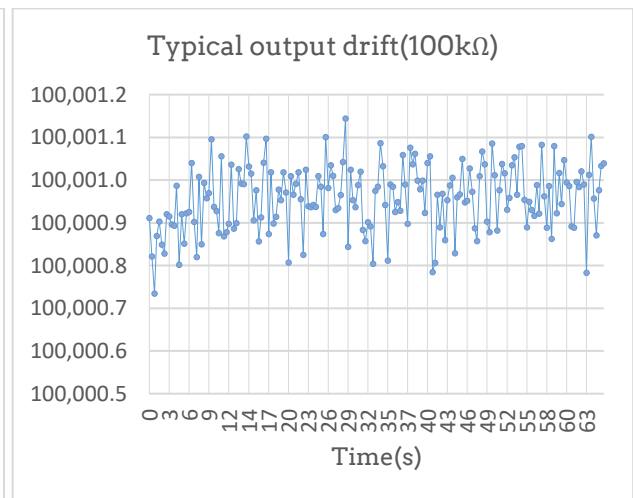
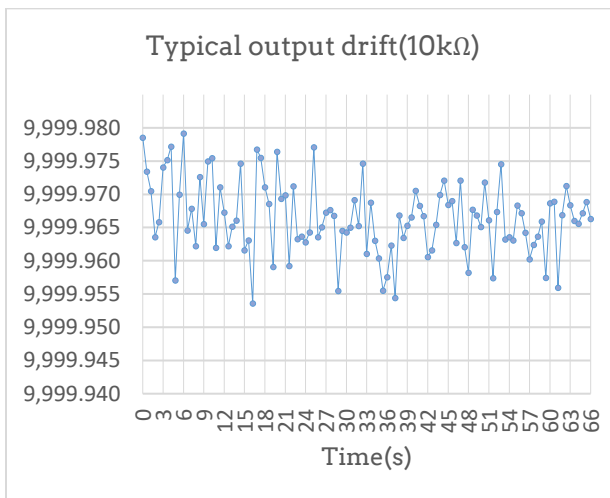
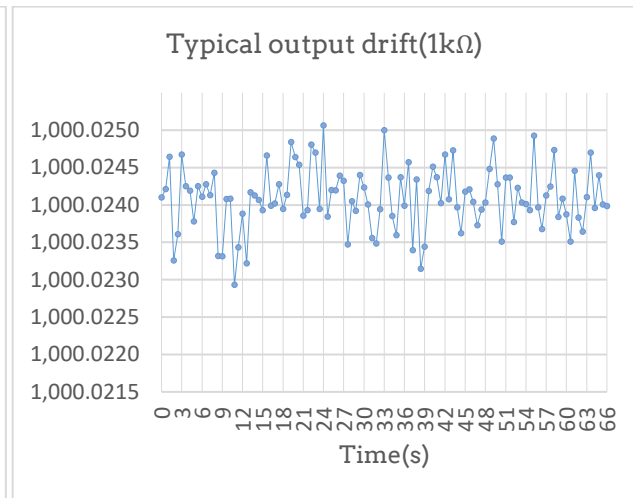
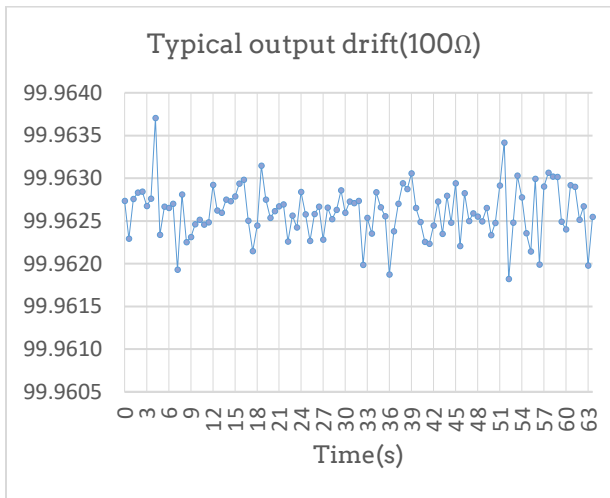
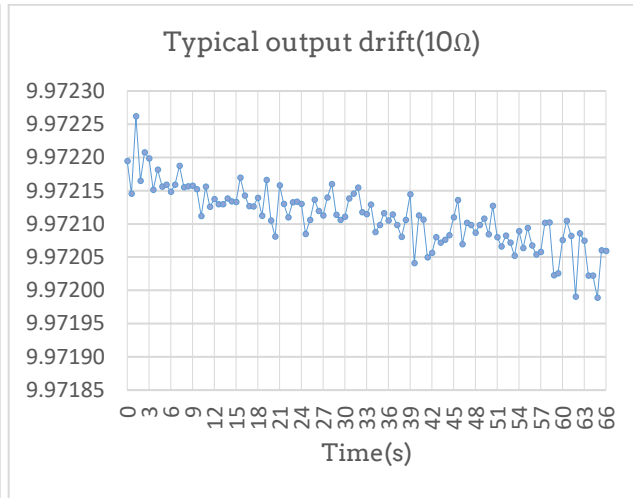
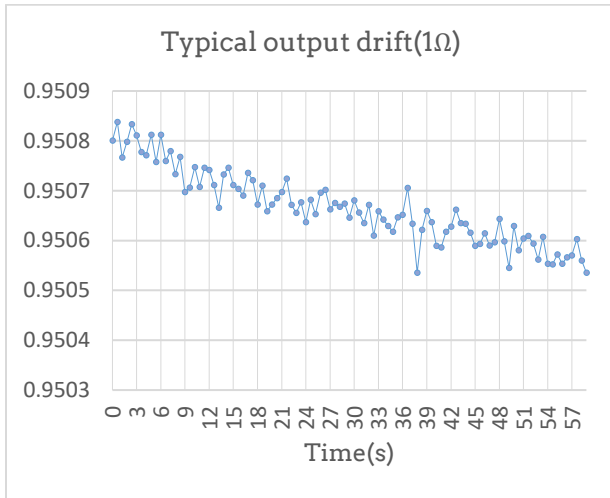



## Typical characteristics (continued)

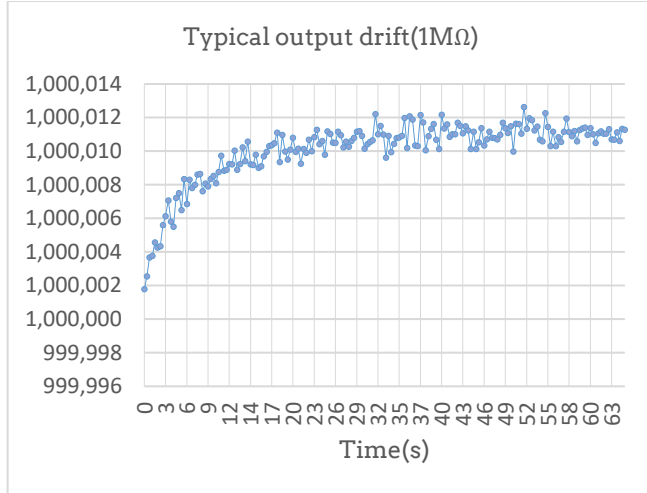

Above graphs: Due to factors such as relay EMF, parasitic capacitance/inductance, the measuring instrument itself, or the measurement method, it usually takes some time for the output resistance measurement to stabilize (excluding relay contact oscillations), the process can last for seconds or even minutes (experience shows that it is related to the number of relays involved in switching). This phenomenon should be considered in high-precision or high-frequency switching applications. The test is performed by starting the measurement at the first moment of the new value output ( $t=0$ ) and recording the measurement data for about 1 min (the above measurement is performed using a 4-wire system with NPLC=5 and a switching sequence of 1MΩ-1Ω-10Ω-100Ω-1kΩ-10kΩ-100kΩ-1MΩ).

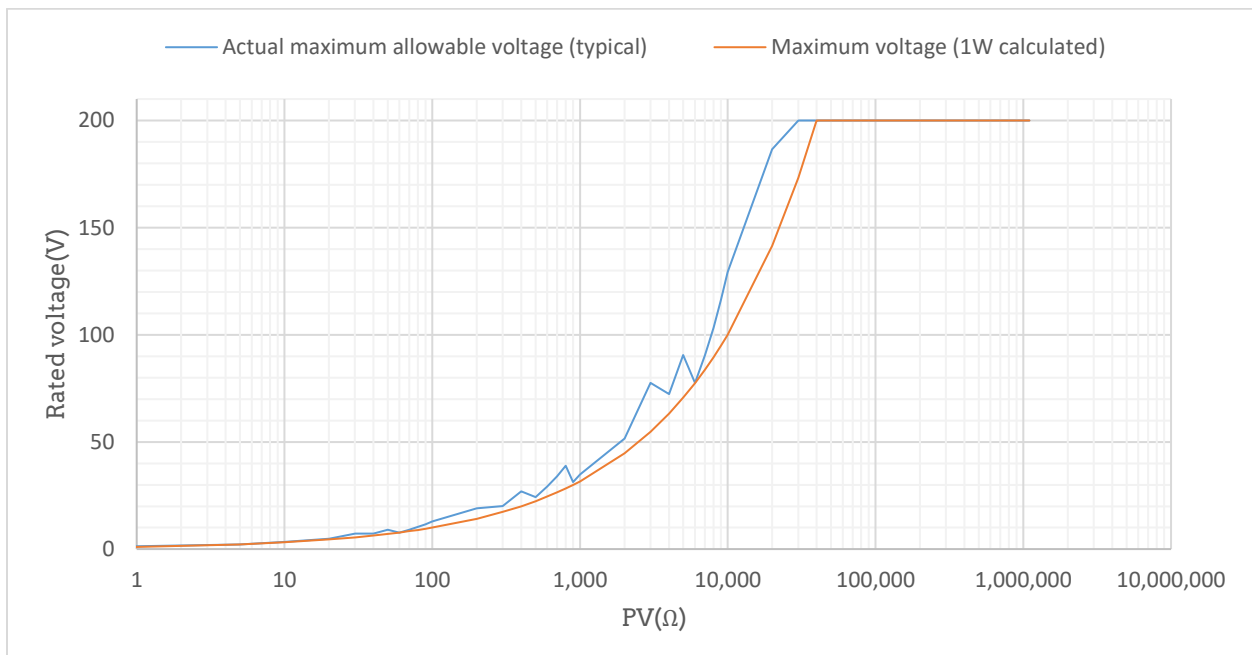

Above: The power rating of the base resistor is 1W, while in practice for most output values (PV), the power rating is usually between 1W and 2W. The user can use it according to the actual MaxU (rated voltage) returned from the serial port; for simplicity, it can also be always treated as 1W according to the rated voltage calculated by the formula  $\text{MaxU} = \sqrt{\text{PV} \cdot 1}$ . It should be noted that the maximum applied voltage across the output resistor should not exceed 200V.

## Principle of operation

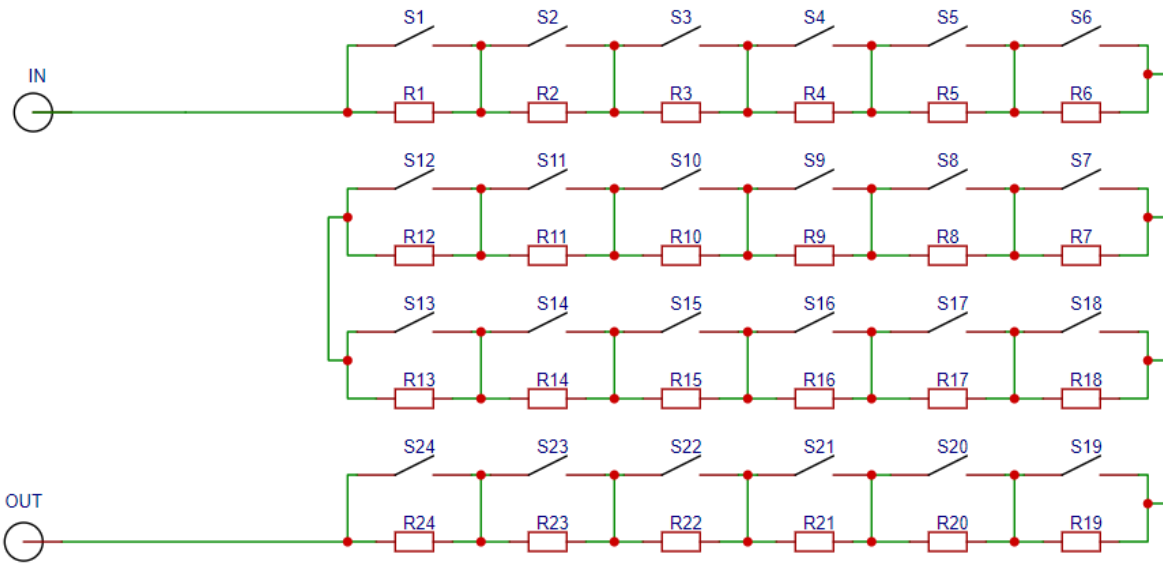

Above: QR101 relay-resistor network schematic (while number of QR100 base resistors is 14). The algorithm is to selectively control the opening and closing of the switches/relays (S1~S24) to selectively pass or shield the base resistors (R1~R24), thus outputting the resistance value (PV) that is closest to the set value (SP). The nominal step value is determined by the smallest base resistance value, and the device cannot perform a scanning output with a smaller step.

## Interface

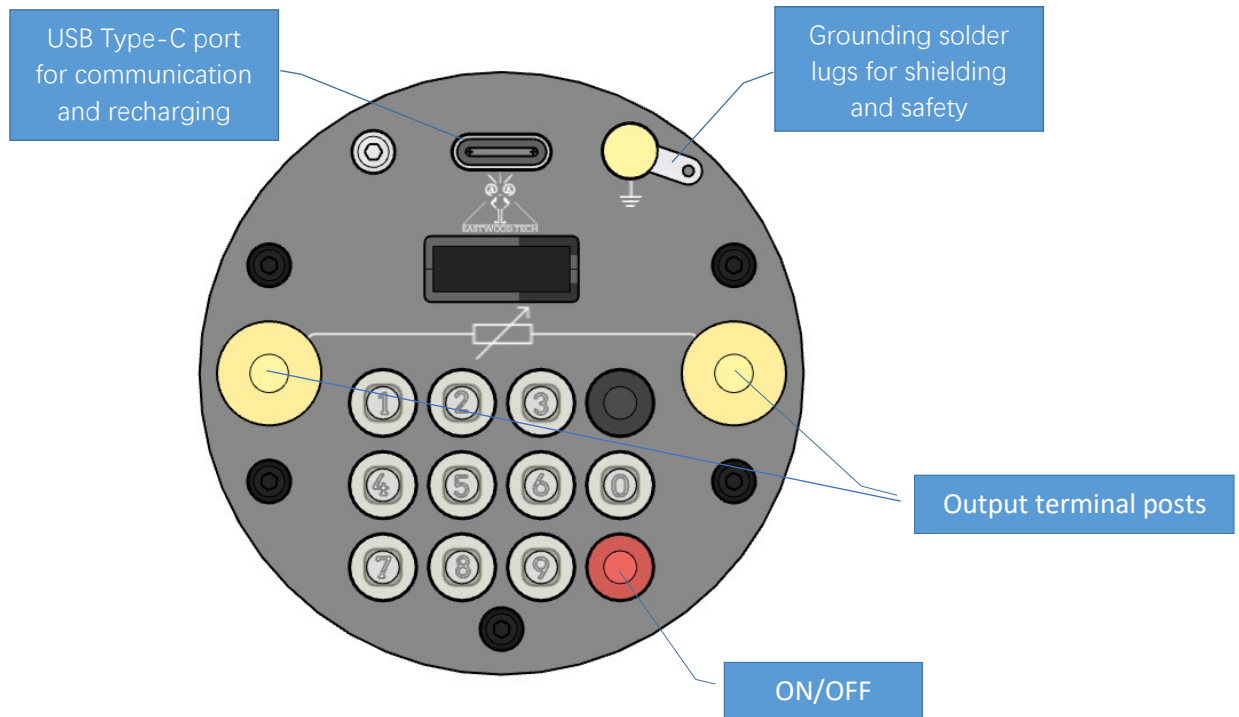

## Instructions for use



### Communication isolation protection

To prevent introducing external interference and to avoid the risk of electric shock during high-voltage use, please use the USB communication isolation module to isolate the host computer and this device.



### Electric shock!

Since the output resistance of this product supports a maximum voltage of 200V DC/AC, when the output terminal is connected to high voltage ( $\geq 36V$  DC/AC), the equipment must be grounded (as well as the hardware isolation of the communication port), and it is forbidden to touch the output terminal to avoid harm or damage to personnel or equipment.

## Operating temperature and humidity

Please use it within the recommended operating environment. Excessive temperature may cause abnormal operation or damage to this device as well as cause a reduction in the rated power of the output resistance; high humidity or condensation may affect the accuracy of the output resistance (especially for above  $1M\Omega$ ) as well as reduce the service life of the device.

## Installation

Not properly grounded results in poor shielding and poor electrical leakage protection.

## Power supply

When used stand-alone, the device uses power from an internal lithium battery. The endurance time is related to the user's operating frequency, generally for several days or weeks. The device will automatically shut down after one hour of no operation. The system will detect the voltage of the lithium battery at each power-on, and cannot be turned on if it is lower than 3.6V, so it should be charged in time.

The product can be powered by a normal USB Type-C cable (for lithium battery charging and serial communication). In the case of an external power supply, the device will disable auto-shutdown.

## Testing

It is critical that the test equipment cables are well shielded and properly grounded, otherwise noise interference may be introduced. The recommended wiring is shown in the following diagram:

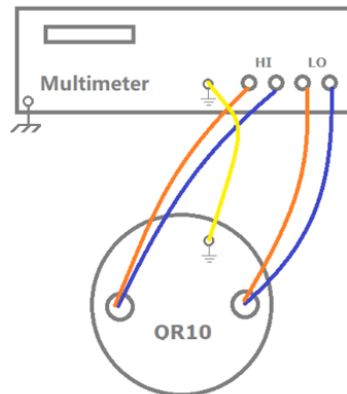

It should be reminded that the distortion of the power supply waveform and noise may also have an impact on the test results, especially if the test instrument shares power with a high-power inductive load. In addition, two-wire measurement must take into account the influence of the resistance of the probe wire.



## User calibration

Having a trusted reference meter, stable ambient temperature, and proper operation (especially for measurements above  $1M\Omega$ ) can bring the module to at least the accuracy claimed in the specification after calibration. In the short term, it is guaranteed that products of class B/A can theoretically follow the reference meter accuracy after calibration (plus uncertainty:  $\pm 0.003\%$  of the reading  $\pm 10m\Omega$ ).

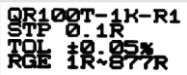
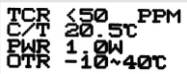

## Keypad operation (since FW v5.93)

Item	Function/Display	Operation	Note/Example
1	Boot up (ON)	Press and hold the red key ● until you see the startup screen	
1.1	Display auto turn off	The screen turns off automatically after 1 minute of inactivity. Press any key to wake up the screen.	USB-Serial COM still working properly under this condition
2	Shutdown (OFF)	Press and hold the red key ● until the screen dims or shuts off	
2.1	Auto shutdown	Without USB cable power supply, the system will shut down automatically after 1 hour of inactivity of key operation; With USB cable, auto shutdown is disabled.	
<b>Page 0 (main page)</b>			
3	Page 0 (main page)	If there is no other operation after booting, the screen that displays "U</SP/PV" is page 0. By default, row SP is hidden (except SP unit). To show SP, hold ● for 1.5 sec.	
3.1	Set SP	On page 0: Number key 0~9 / the black key ● (decimal point) + the red key ● (enter/ok)	Note: The first digit of the set value cannot be a decimal point.
3.2	Cancel SP setting	During 3.1 editing (before clicking the red key): - double click ● to cancel editing. - Two decimal points in the SP string like "123.45." will also cancel editing.	The system will return to page 0
3.3	Change SP unit	On page 0: Click ●, SP unit changes in the order of "Ω" → "K(kΩ)" → "M(MΩ)"	
3.4	Rated power	On page 0: The first line "U<" indicates the rated voltage of the current PV	After each update of SP, the corresponding rated voltage value is also refreshed.
3.5	Output value (PV)	On page 0/2, row 3	The definition of accuracy is based on PV and its corresponding reference value.
<b>Page 1 (sensor page)</b>			
4	Page 1	On page 0, click ● to switch to page 1	
4.1	Battery voltage (VB)	On page 1 (row 1)	Cannot boot up if VB<3.6 V. Normal VB ranges from 3.6 V (low power) ~ 4.2 V (fully charged)
4.2	Temperature Sensor (TS)	On Page 1 (row 2)	It might be 1~2 degrees higher than the ambient temperature when the device warmed up
4.3	Back to page 0	On page 1, click ●,	

## Keypad operation(continued)

Page 2 (output limit page)			
5	Page 2	On page 1, click ● to switch to page 2	
5.1	Output min. limit (R>)	On the first row of page 2	"R>" default value is "0", i.e. any SP that is greater than "0" is allowed
5.2	Set output min. limit (R>)	On page 2: Number key 0~9 / the black key ● (decimal point) + the red key ● (enter/ok)	If the current SP < limit value, Output (PV) will be forced to be the latter and with a mark "*" on display near "PV".
5.3	Set output min. limit (R>) unit	On page 2: Click ●, unit changes in the order of "Ω" → "K(kΩ)" → "M(MΩ)"	Weight of the number key changes according to "unit".
5.4	Back to page 0	<ul style="list-style-type: none"> <li>- After setting a new limit value, click ● again to return to page 0;</li> <li>- Click ● back to page 0.</li> </ul>	
Device information			
6	Device info. (1/3)	On page 0: Use combination keys "● + number key ①" to view device info. (1/3): <ul style="list-style-type: none"> <li>- Device Type/order code</li> <li>- Step (STP)</li> <li>- Tolerance (TOL)</li> <li>- Output range (RGE)</li> </ul>	<i>Note: When device info. is displaying, some AT commands cannot be executed in real-time.</i> Screen demo of device info. (1/3): 
6.1	Device info. (2/3)	In the state of item 6: Click ●: <ul style="list-style-type: none"> <li>- T.C.R(TCR)</li> <li>- Calibration temperature (C/T)</li> <li>- Rated power (PWR)</li> <li>- Operating Temperature Range (OTR)</li> </ul>	Screen demo of device info. (2/3): 
6.2	Device info. (3/3)	In the state of item 6.1: Click ●: <ul style="list-style-type: none"> <li>- Hardware version (H/W)</li> <li>- Firmware version (H/W)</li> <li>- Serial Number (S/N)</li> <li>- Production date (PRD), yyyymmdd</li> </ul>	Screen demo of device info. (3/3): 
6.3	Back to page 0	In the state of item 6.2: Click ● or wait about 30 sec.	

## Keypad operation(continued)

Auto-scanning			
7	Auto-scanning (1/2)	<p>On page 0: Use combination keys "● + number key ②" to enter auto-scanning setting menu:</p> <ul style="list-style-type: none"> <li>- Enable auto-scanning (EN), click ● to switch between "ON" and "OFF"</li> <li>- Loop (LOP), click ● to switch between "YES" and "NO"</li> <li>- Scanning direction (DIR), click ● to switch between "+, INC (increasing)" and "-", DEC (decreasing)"</li> </ul>	 <p><i>More flexible scanning functions can be realized via AT commands</i></p>
7.1	Auto-scanning (2/2)	<ul style="list-style-type: none"> <li>- Scanning period (<math>\Delta T</math>), use number keys to enter a value from 1 s to 99 s.</li> <li>- Scanning steps (<math>\Delta R</math>), use number keys + ● (decimal point) to enter a value</li> <li>- Scanning range low (MIN), same as above</li> <li>- Scanning range high (MAX), same as above</li> </ul>	 <p>Units of <math>\Delta R</math>, MIN, and MAX are non-editable, but they can be changed automatically based on the current (setting) value.</p>
7.2	Save & activate the following item	Click ● to save the current item and activate the following item	The ■ is used to indicate the active row which is editable.
7.3	Set initial value for scanning	<ul style="list-style-type: none"> <li>- Set it via SP on page 0 before auto-scanning is enabled (recommended)</li> <li>- Set it on page 0 after auto-scanning is enabled (SP unit is fixed to "Ω") via AT command</li> </ul>	By default, the scanning initial value is the current SP.
7.4	Pause/Start	Click ● to pause/start auto-scanning during the operation on page 0	<p>(image)</p> <p>A "*" before SP to indicate SP is modified by auto-sacnning; a "  " means "pause of auto-scanning"</p>

## Keypad operation(continued)

User calibration			
8	User calibration	On page 0: Use combination keys “● + number key ③” to enter the user calibration setting menu.	Connect reference multimeter probes to QR10 binding posts first. A 4-wire connection is recommended.
8.1	Exit	Hold ● for 1.5 sec. to return to the main page.	All editing items were saved before exit. <i>For FW v5.93~v5.96, need to reboot the device after new setting.</i>
8.2	Enable(EN)	Click ● to switch between “ON” and “OFF”. - “ON”: use user calibration data as the reference - “OFF”: use factory calibration data as reference	On main page row 1, <b>F</b> indicates “factory calibration data is in application” while <b>U</b> stands for “user calibration data is in application”.
8.3	Record calibration temperature (C/T) – 1/28	- Click ● to load a value from the built-in temperature sensor (recommended) - Click ● again to cancel, or click ● to confirm.	Can also set the value via keypad (refer to 3.1). Still can edit (set a new value) after confirmation.
8.4	Save & page down	Click ● to save the current item and turn to next page	
8.5	Record min. output (RMIN – 2/28)	- Set the reference value via keypad (refer to 3.1), - Or click ● to load a default value and click ● to confirm.	Default values can be used to check the “healthy” of the device as relays get aged.
8.6	Record calibration point 0 (R00 – 3/28)	- Set the reference value via keypad (refer to 3.1), - Or click ● to load a default value and click ● again to cancel/click ● to confirm.	
8.7	Record calibration point 1 (R01 – 4/28)	- Set the reference value via keypad (refer to 3.1), - Or click ● to load a default value and click ● again to cancel/click ● to confirm.	
...	Record calibration Point 2 ~ point 23	...	R02~R23, all the same operation as 8.5~8.7 mentioned.
8.8	Record calibration max. output(RMAX – 27/28)	- Set the reference value via keypad (refer to 3.1), - Or click ● to load a default value and click ● again to cancel/click ● to confirm.	For > 1 MΩ value, may need to wait several minutes until it gets stable.
8.9	Record calibration date	Set the date via keypad number keys. A string of 8 bytes is free for saving.	After the save & page down operation (8.4), return to the main page and the new setting take effect immediately (for FW v5.93~v5.96, need to reboot the device)

## AT command set

Users can remotely control the instrument and check device information via serial COM software.

Configuration		
<b>Driver IC</b>	WCH CH340	<a href="#">驱动链接 (Driver link)</a>
<b>Driver installation</b>	Turn on the device, and connect it to PC via a USB type-C cable. Select the driver to install manually or let the PC do auto-scanning for installation.	After successful installation, the following information can be found through Device Manager (Windows): <ul style="list-style-type: none"> <li>Ports (COM &amp; LPT)</li> <li>USB-SERIAL CH340 (COM28)</li> </ul>
<b>Baudrate &amp; settings</b>	115,200 bps, 8 data bits, no parity, and 1 stop bit	
<b>End mark (EOT)</b>	\r or \n	<i>Necessary for each command.</i>

### AT Command Set Table

No.	Description	Instruction (need to add '\r' or '\n' at the end of each command)	Default Unit	Example (communication log.)
① Basic instructions				
1	Get SP	AT+USER.SP?	Ω	TX: AT+USER.SP? RX: +USER.SP=1.0000
2	Set SP	AT+USER.SP=<float string>	Ω	TX: AT+USER.SP=2 RX: +OK. RX: SP(R)=2.000 PV(R)=2.009 UMax(V)=1.5 RLimit(R)=0.000 InnerT(C)=27.68
3	Set SP (Increasingly)	AT+USER.SP+=<float string>	Ω	<i>Initial status: SP=2.0</i> TX: AT+USER.SP+=1 RX: +OK. RX: SP(R)=3.000 PV(R)=3.014 UMax(V)=1.8 RLimit(R)=0.000 InnerT(C)=27.68
4	Set SP (Decreasingly)	AT+USER.SP-=<float string>	Ω	<i>Initial status: SP=3.0</i> TX: AT+USER.SP-=1 RX: +OK. RX: SP(R)=2.000 PV(R)=2.009 UMax(V)=1.5 RLimit(R)=0.000 InnerT(C)=27.68
5	Get PV	AT+USER.PV?		TX: AT+USER.PV? RX: +USER.PV=10.024



## AT Command Set Table(continued)

6	Get safety output limit	AT+USER.RLIMIT?	Ω	TX: AT+USER.RLIMIT? RX: +USER.RLIMIT=0.0000
7	Set safety output limit	AT+USER.RLIMIT=<float string>	Ω	TX: AT+USER.RLIMIT=10 RX: +OK. RX: SP(R)=2.000 PV(R)=10.024 UMax(V)=3.4 RLimit(R)=10.000 InnerT(C)=27.59
8	Get internal temperature	AT+USER.T_SENSOR?	°C	TX: AT+USER.T_SENSOR? RX: +USER.T_SENSOR=27.66
<b>② User calibration</b>				
9	Get calibration data reference source	AT+UCAL.EN?		TX: AT+UCAL.EN? RX: +UCAL.EN=0  <i>'1': User calibration data activated</i> <i>'0': Factory calibration data activated</i>
10	Enable/disable user calibration data	AT+UCAL.EN=<'1'/'0'>		TX: AT+UCAL.EN? RX: +UCAL.EN=0  <i>'1': Activate user calibration data</i> <i>'0': Activate factory calibration data</i>
11	Get user calibration info.	AT+UCAL.INFO?	Ω	TX: AT+UCAL.INFO? RX: +UCAL.INFO: USEN =0 DATE=20221025 TEMP=27.13 MAX(cali)=8553299 MAX(math)=8553284 MIN =1.0120 CH0=2.1000 CH1=3.0500 CH2=4.9900 ...
<b>③ Device info.</b>				
12	Get T.C.R	AT+DEV.TCR?	ppm	TX: AT+DEV.TCR? RX: +DEV.TCR=25
13	Get device type	AT+DEV.TYPE?		TX: AT+DEV.TYPE? RX: +DEV.TYPE=QR101B-AM-1R
14	Get production date	AT+DEV.PROD?		TX: AT+DEV.PROD? RX: +DEV.PROD=<yyyymmdd>
15	Get serial number	AT+DEV.SN?		TX: AT+DEV.SN? RX: +DEV.SN=00000127
16	Get HW version	AT+DEV.HW?		TX: AT+DEV.HW? RX: +DEV.HW=5.1N
17	Get FW version	AT+DEV.FW?		TX: AT+DEV.FW? RX: +DEV.FW=5.963KS

## Example of use

- **Example 1 (Power on and set SP to 1kΩ via keypad)**

Step 1:

Press and hold the red button until the screen appears, release the button and wait to enter the main page (page 0).

Step 2 (optional):

Click on the black button to switch SP/PV units. Refer to Keypad Operation 3.3.

Step 3:

If the SP/PV unit is "Ω", click "1", "0", "0", and "0" and then click the red button to confirm;

If the SP/PV unit is "K", click "1" and then click the red button to confirm;

If the SP/PV unit is "M", click "0", the black button (decimal point), "0", "0", "1", and finally click the red button to confirm.

- **Example 2 (USB-Serial port setting SP to 10kΩ)**

Step 1:

Configure the serial port communication baud rate and other settings correctly.

Step 2:

Send "AT+USER.SP=100000\r\n"

## Self-check

Item	Display message	Action
1	Show "VB<*V" when powered up	Refuse working if battery voltage <3.6 V. Should recharge it soon. "*" represents the current battery voltage.
2	ERR.01	Click the red key to shut down. Please contact the manufacturer for a solution.
3	ERR.02	Click the red key to shut down. Please contact the manufacturer for a solution.

## Maintenance (Important)

- *Do not overload.*
- *Do not use in humid environments and avoid water ingress.*
- *Please keep the shell clean (sweat stains may penetrate the surface paint layer and chemically react with brass to produce black rust spots)*
- *Storage conditions, the built-in lithium battery shelf life of about 10 months, it is recommended to replenish the battery every 8 months.*
- *The contact on-resistance of mechanical relays and base resistors may age due to use, so annual calibration is recommended.*

# Appendix 1 (sample calibration certificate)



## Certificate of Calibration & Testing

Laboratory: ShenZhen lab.

- Show true values.

Model: **QR101B-2M-RX**  
 Serial Number: **00000289**  
 Description: **Programmable Resistance Substitution Box with USB-COM Port**  
 Built-in Temperature Sensor: **YES**  
 Allow User Calibration: **YES**  
 Calibration Approach: **Via output terminals**  
 Calibration Date: **30-Nov-2022**  
 Calibration Temperature<sup>1</sup>: **22.4 ± 0.3 °C**

Firmware: **v 5.968KS**  
 Hardware: **v 5.1N**  
 TCR(>100 Ω): **<25 ppm**

Customer: **<null>**  
 Purchase Platform: **<null>**  
 Address: **<null>**

Check Points			
SP(Ω)	PV(Ω)	Ref. (Ω)	DMM Accu.
1	0.9420	0.9395	0.031%
2	1.9550	1.9523	0.020%
3	2.9580	2.9554	0.017%
4	3.9710	3.9681	0.015%
5	4.9450	4.9417	0.014%
6	5.9580	5.9544	0.013%
7	6.9600	6.9574	0.013%
8	7.9730	7.9702	0.013%
9	8.9620	8.9601	0.012%
10	9.9410	9.9387	0.012%
20	20.0360	20.0335	0.020%
30	30.0090	30.0059	0.017%
40	40.0360	40.0313	0.015%
50	49.9960	49.9924	0.014%
60	60.0540	60.0501	0.013%
70	70.0550	70.0515	0.013%
80	79.9870	79.9830	0.013%
90	90.0140	90.0086	0.012%
100	100.0160	100.0103	0.012%
200	200.0360	200.0280	0.012%
300	299.9530	299.9486	0.011%
400	400.0230	400.0141	0.010%
500	500.0110	500.0130	0.010%
600	599.9460	599.9442	0.010%
700	699.9550	699.9537	0.010%
800	799.9480	799.9449	0.010%
900	899.9870	899.9647	0.010%
1000	999.9700	999.9430	0.010%
2000	2000.041	2000.018	0.012%
3000	3000.055	3000.013	0.011%
4000	4000.010	3999.917	0.011%
5000	5000.031	4999.933	0.010%
6000	6000.041	5999.964	0.010%
7000	6999.978	6999.874	0.010%
8000	7999.975	7999.861	0.010%
9000	8999.989	8999.853	0.010%
10000	9999.995	9999.803	0.010%
20000	19999.99	20000.05	0.015%
30000	29999.96	30000.41	0.013%
40000	39999.98	40000.50	0.012%
50000	50000.07	49999.52	0.012%
60000	60000.03	59999.57	0.012%
70000	69999.99	69999.88	0.011%
80000	79999.97	79999.80	0.011%
90000	89999.98	89997.94	0.011%
100000	100000.0	99997.92	0.011%
200000	200000.0	200003.0	0.015%
300000	299999.9	300000.7	0.014%
400000	400000.0	400004.6	0.013%
500000	500000.0	500009.7	0.013%
600000	599999.9	600005.6	0.013%
700000	699999.9	700023.9	0.013%
800000	800000.0	800027.1	0.013%
900000	900000.0	900025.5	0.013%
1000000	1000000	1000031	0.013%
1100000	1100000	1100035	0.013%
1253493	1253493	1253589	0.014%

Calibration Points		
Points	Ref. (Ω)	DMM Accu.
1	1.0761	0.029%
2	1.2026	0.027%
3	1.4508	0.024%
4	1.9549	0.020%
5	2.9576	0.017%
6	4.9447	0.014%
7	8.9282	0.012%
8	16.8732	0.022%
9	30.9024	0.016%
10	59.9194	0.013%
11	110.8377	0.012%
12	222.0163	0.012%
13	423.0865	0.010%
14	824.5700	0.010%
15	1500.329	0.013%
16	3048.279	0.011%
17	5991.546	0.010%
18	11508.75	0.010%
19	22132.71	0.015%
20	41073.84	0.012%
21	82533.27	0.011%
22	155936.4	0.016%
23	304318.2	0.014%
24	623760.8	0.013%
Min.	0.9420	0.031%
Max.	1253559	0.014%

Reference Meter: Keithley DMM6500  
 Reference Meter Accuracy<sup>2</sup>: ("DMM Accu." column on tables)  
 4-wire Mode: YES (cable with shielding)  
 Auto Range: ON  
 Auto-zero: ON  
 NPLC: 2  
 Filter: OFF  
 Power Supply: 220 VAC, sine wave harmonic distortion < 2%

Data Processing: Average  
 Data Average (<1.2 MΩ): Remove relay switching effect  
 Data Average (>1.2 MΩ): Remove EMF effect

DUT Grounding: YES  
 Check Condition<sup>3</sup>: 18.8 ± 0.3 °C  
 Check Date: 1-Dec-2022

Results: **Class B PASSED**  
 Operator: *Christina*  
 Signature:

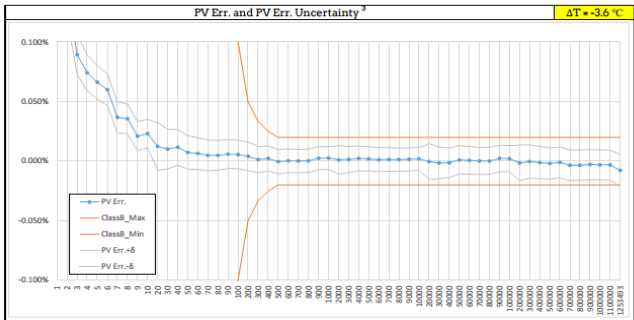

<sup>1</sup> Data is collected from built-in temperature sensor. It might be 1-2 °C higher than the actual ambient temperature.  
<sup>2</sup> Based on DMM6500's datasheet. For the range >1.2 MΩ, DMM Accuracy has been corrected manually.  
<sup>3</sup> Straight PV err. = (PV - Ref.) / Ref. \* 100%, shown as the blue curve on chart; Boundary of PV err. uncertainty (δ) is calculated by:  
 $\delta = |PV - Ref. | * (1 \pm DMM Accu.) / |Ref. | * (1 \pm DMM Accu.) * 100%$ , shown as the area between the gray curves.

Doc. Created: 12-Jun-2023

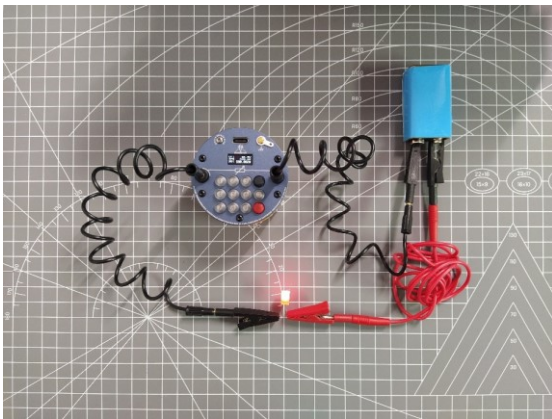

**Eastwood Instruments**

**- Always do better.**

**For more information:**

[www.eastwood.tech](http://www.eastwood.tech)

**Protected by CN patents:**

ZL202122003046.7

ZL202130497759.6

©2021-2023 Eastwood Instruments.

Specifications subject to change without notice.

This document was written and published by Channing Chang. **Modification of this document is not permitted without written permission from Eastwood Instruments.**