

# Fibonacci (SMD)

## Information and Assembly Guide



**Sleepy Pony Labs**

sleepyponylabs.com

Document Revision **2** for Board Revision **1**

For the latest updates, visit us at

<https://sleepyponylabs.com/>

# Introduction

Welcome and thank you for purchasing the Fibonacci SMD soldering kit from Sleepy Pony Labs! The Fibonacci SMD is a soldering practice board that use old-school logic chips to calculate numbers in the Fibonacci sequence from 0 to up to 46,368 and display them on a set of 7-segment display.

This kit is designed for beginners practicing surface mount soldering. There are multiple types of devices available to solder on the board and most of them have duplicates for you to solder multiple times. After you have finished soldering, it could be put into a common 4x6 inches photo frame for show.

## Specifications

- **PCB board:** Green FR4 board of size 4\*6 inches
- **Parts count:** 59 pieces
- **Power supply:** 5v DC adapter, 5.5x2.5 mm, center positive (not included)
  
- **Soldering Difficulty:** 4/10
- **Soldering Type:** SMD only, smallest pitch 1.27 mm
  
- **Firmware parts:** PIC16F721 x1 (with ICSP header)

## Unpacking List / Bill of Materials (BOM)

References	Description	Quantity
C1 – C15	100nF Ceramic Capacitor	15
C16, C19	100uF Electrolytic Capacitor	2
C17	10nF Ceramic Capacitor	1
C18	10uF Electrolytic Capacitor	1
R1, R2, R4	10 kΩ Resistor	3
R3, R5 – R8	4.7 kΩ Resistor	5
RN1	330 Ω Resistor (7x)	1*
RN2	1 kΩ Resistor (5x)	1*
D1	Red LED	1
U1	74HC32 Logic IC	1
U2	74HC74 Logic IC	1
U3 – U6	74HC273 Logic IC	4
U7 – U10	74HC283 Logic IC	4
U11 – U12	74HC165 Logic IC	2
U13	PIC16F721 Microcontroller	1
U14	CD4017 Logic IC	1
U15	NE555 Timer IC	1
U16 – U20	7-Segment Display (single digit, common anode)	5
SW1	SMD Slide Switch	1
Q1 – Q6	MMBT2907 PNP Transistor	6
Q7	MMBT2222A NPN Transistor	1
J1	SMD DC Jack (5.5x2.5mm barrel)	1
	<b>Total</b>	<b>59</b>

**Note:** RN1 is 7 separate 0805 resistors, and RN2 is 5 separate 0805 resistors.

**Note:** High-Resolution image of the PCB is on page 15.

**Note:** ICSP header not included.

**Note:** We strongly recommended that you use the interactive BOM during unpacking and assembling. It will make your life much easier. It is available here: [https://www.sleepyponylabs.com/ibom/html/ibom\\_fibonacci\\_smd\\_rev\\_1.html](https://www.sleepyponylabs.com/ibom/html/ibom_fibonacci_smd_rev_1.html)

# Assembly Guide

**The general guide in soldering anything is to solder components with the lowest profile (least in height) first before soldering other taller components.**

**This guide sums up my experience in soldering the board during the testing. Follow the steps here to reduce possible problems.**

**Note:** Before we proceed, since this kit contains SMD parts, I would like to give some recommendations first.

- Be careful while unpacking. Remove parts from their tubes/tapes ONLY when you need it and be careful while doing so. SMD parts are very hard to identify and easy to lose after they leave their packaging.
- Conical tip that comes with most soldering iron will not work well with SMD (or anything really). I recommended you get a horse hoof tip (Hakko type C) or a chisel tip (Hakko type D) because these will transfer heat better, act as a reservoir for solder which you can use to both add and remove solder from a joint and allow you to perform neat tricks such as drag soldering.
- Make sure you have all the tools needed. At the minimum, I suggest you have a temperature-controlled soldering-iron, a tweezer, good brand of solder, flux, and solder wick. Do NOT use eBay junk please.
- SMD pads are small and easier to break than through-hole counterparts. Use temperature between 350-400 Deg Celsius while soldering and do not hold your iron on the pads too long because that is how you lift them off. If the solder bridge between pads, a lot of flux and solder wick helps. You might find a soldering pump easier for you, but from my own experience it has a higher chance of damaging the board.
- While tacking one side down first then solder the other side is a standard practice for parts with two pads, you might find putting a part on the board, applying flux, then use already melted solder on your iron to tack both sides in one go easier. Try and see which way works best for you.
- **Do not afraid to try. We all start somewhere.**

## 1. IC

Align the chip with the pads. The Pin-1 Mark on the chip should match the longer white line on the board. Hold the chip with tape then solder diagonal pins first so it will not move around (for example, pin 14 and 28, or pin 1 and 15). Then solder the rest of the pins.

You might want to check out SOIC/SOP soldering tutorial online first. For example: <https://youtu.be/-15D2em4PBI> from Androkavo.

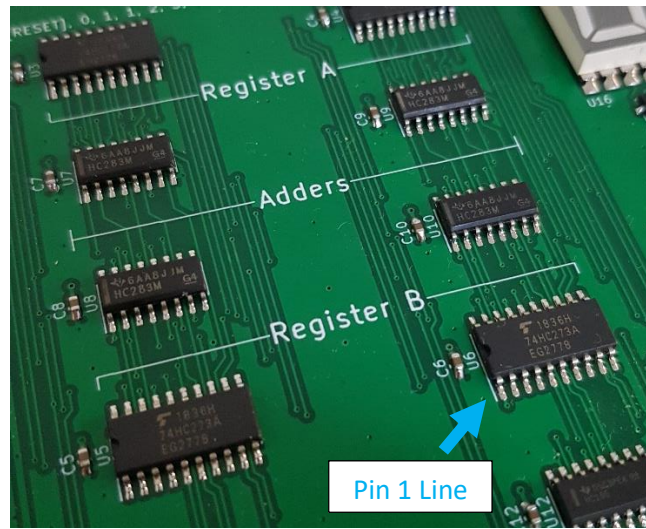

## 2. Resistor

Remove the parts from its packaging onto the board. Flip them so that the side with numbers is up. First, put small amount of solder on one pad, then use your tweezers to hold the resistor to the pad. Heat the pad up again until the solder flows to the resistor. Finally, solder the remaining pad.

**Note:** You can touch up with an iron and flux if you have cold joints.

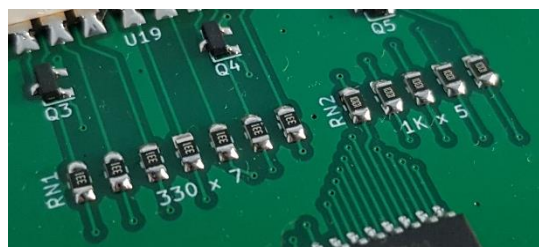

*Note: This is also how you install RN1 and RN2.*

### 3. Ceramic Capacitor

Remove the parts from its packaging onto the board. Flip them so that they lay flat to the board. First, put small amount of solder on one pad, then use your tweezers to hold the resistor to the pad. Heat the pad up again until the solder flows to the capacitor. Finally, solder the remaining pad.

**Note:** You can touch up with an iron and flux if you have cold joints.



### 4. LED

Remove the parts from its packaging onto the board. Check the polarity of the LED before you flip it. First, put small amount of solder on one pad, then use your tweezers to hold the resistor to the pad. Heat the pad up again until the solder flows to the capacitor. Finally, solder the remaining pad.

**Note:** You can touch up with an iron and flux if you have cold joints.

**Note:** SMD LEDs are fragile. Do not touch the lenses of the LED with your iron or tweezers. Also do not add too much solder.

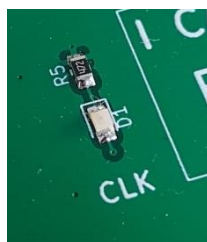

Top Line = Cathode

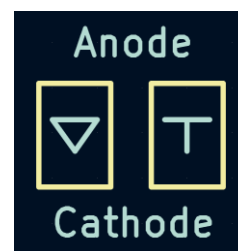

How to identify polarity (bottom view)

## 5. Transistor (SOT-23)

Remove the parts from its packaging onto the board. Flip them so that the right side is up. Solder one pin first to hold in place, then solder the rest of the pins.

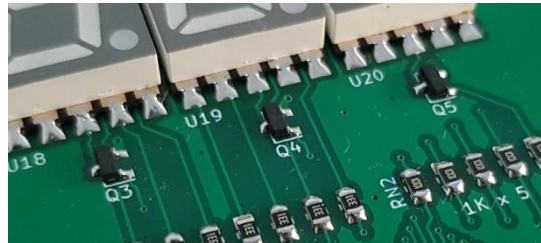

## 6. 7-Segment Display

Place the display on the footprint. Make sure the decimal point is at the bottom of the display. Hold it with tape and solder it.

**Note:** If your display comes with a protective sticker and you plan to clean the board with flux cleaner or alcohol later, leave the sticker intact for now and only remove it after you are done. **Cleaning solutions will dissolve the black display coating.**

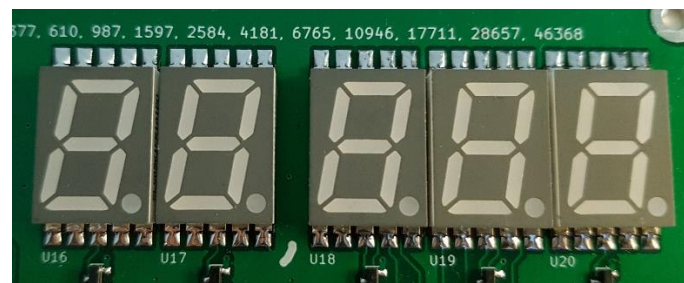

## 7. SMD Slide Switch

Remove the parts from its packaging onto the board. Align the part on the footprint. Solder diagonal pins first to hold it in place, then solder the rest of the pins.



## 8. Electrolytic Capacitors

Remove the parts from its packaging onto the board. Align the plastic base of the capacitor to match the silkscreen on the board. Solder one pin first to hold it in place, then solder the remaining pin.

**Note:** The color block on electrolytic capacitors denotes the negative pin.



## 9. Barrel Jack

Align the connector to the footprint. The plastic dimples on the bottom of the jack should match the holes on the board. Solder diagonal pins first to hold it in place, then solder the rest of the pins.

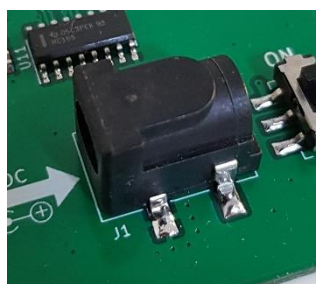



## How to Use

After all the parts were soldered, connect the 5V power source and turn the switch to ON position. All of the 7-segment displays should light up 00000.

Every time the CLK LED flashes, the display should update to the next number in the Fibonacci sequence (as written on the top of the board).

When the display reaches 46368, the highest number that could fit in a 16-bit register, the circuit will reset back to 00000 and start counting from the beginning again. The circuit will loop indefinitely until it is turned off.

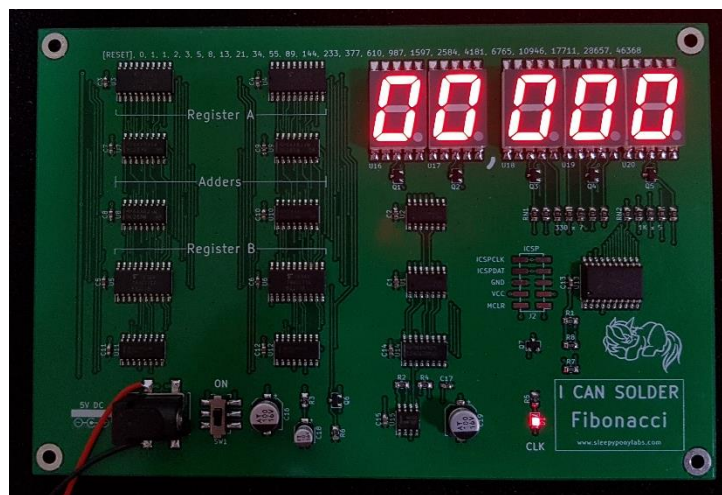

**Correct Power-On Behavior**

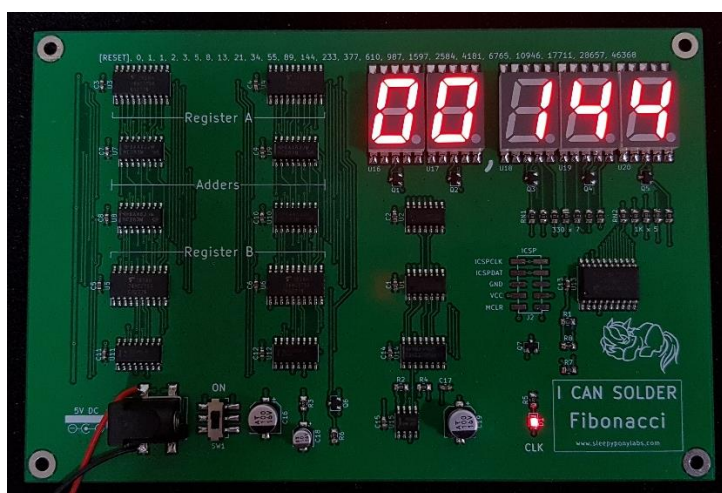

**Correct Running Behavior**

# Troubleshooting

In case your circuit does not work, the list below contains some possible causes of the issue from most likely to least likely:

- Bad solder joints (Cold joints, Short between joints, Unconnected joints)
- Incorrectly installed components (Wrong location or orientation)
- Bad power supply (Battery dry, Wrong type, Wrong polarity)
- Components damaged by soldering heat.
- Components damaged by static electricity or broken from the factory.
- PCB damaged by soldering heat or impact (Broken pads or traces).

And these are possible causes specific to this kit:

- None found so far. If you have something concerning, please contact me on my website or on Tindie. Thanks!

# Schematics

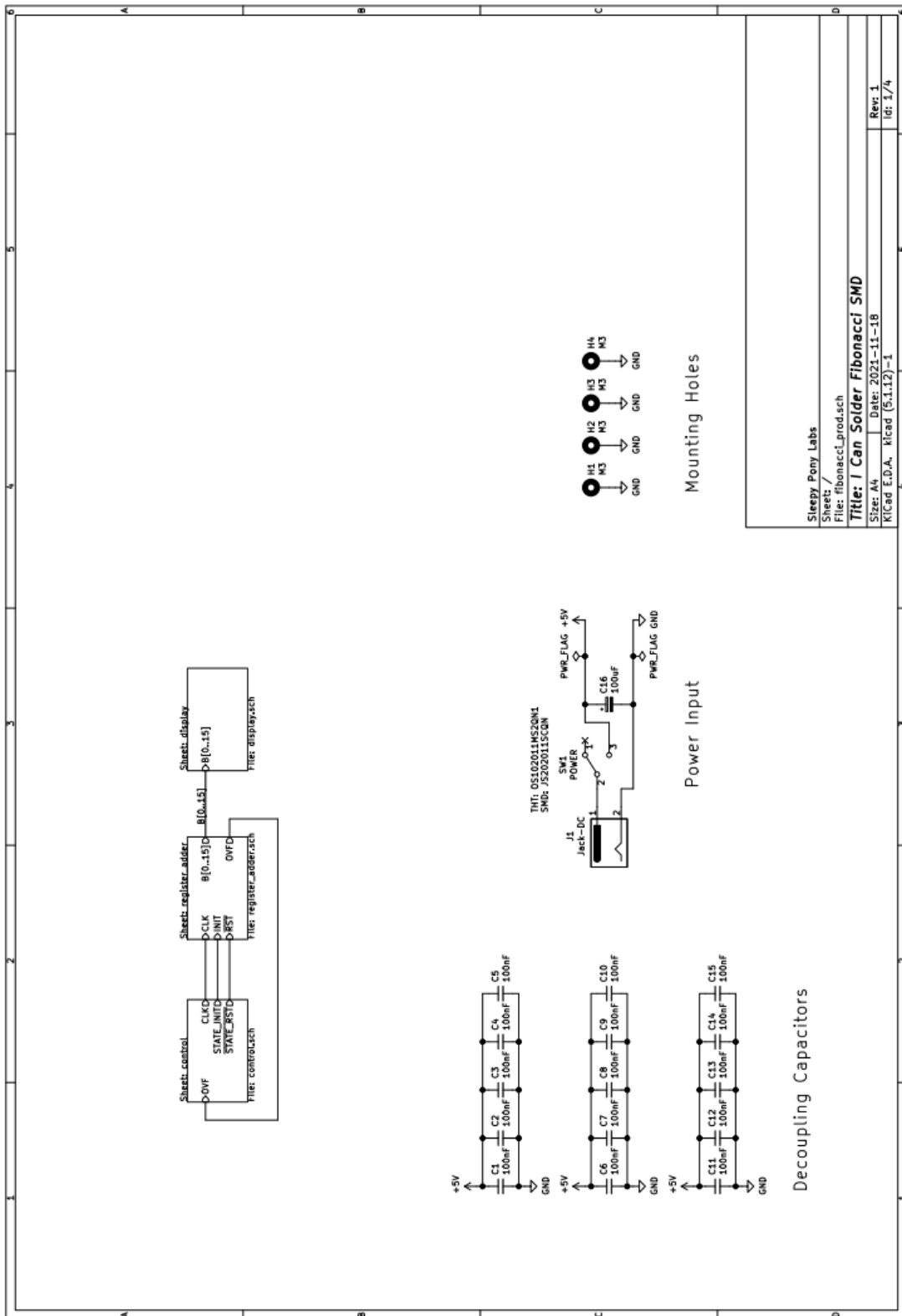

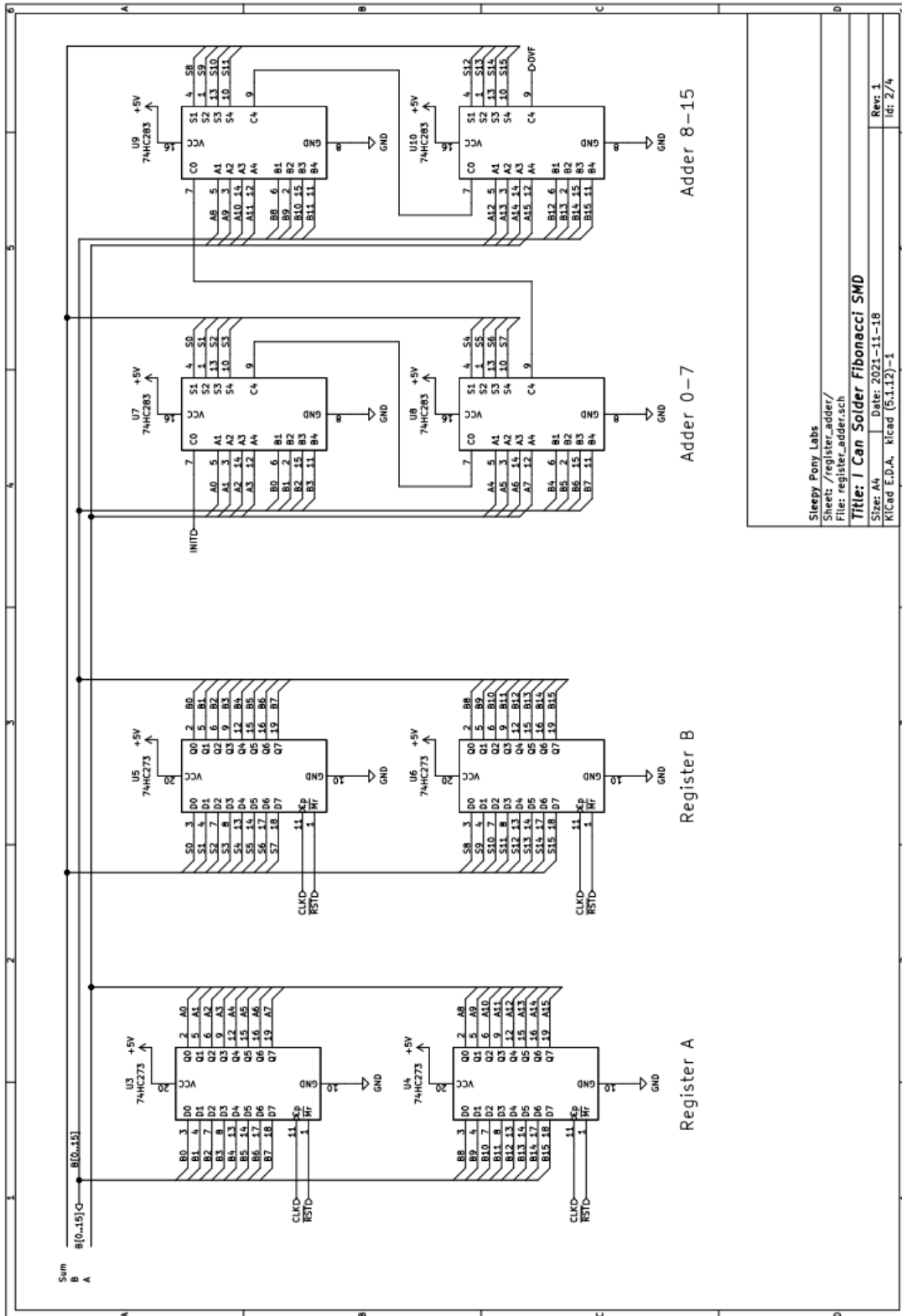

Sineey Popy Labs  
 Sheet: /register\_addr/  
 File: register\_addr.sch  
**Title: 1 Can Solder Fibonacci SMD**  
 Size: A4 Date: 2021-11-18 Rev: 1  
 K/Cad E.D.A. K/cad (5.1.12)-1 Id: 2/4

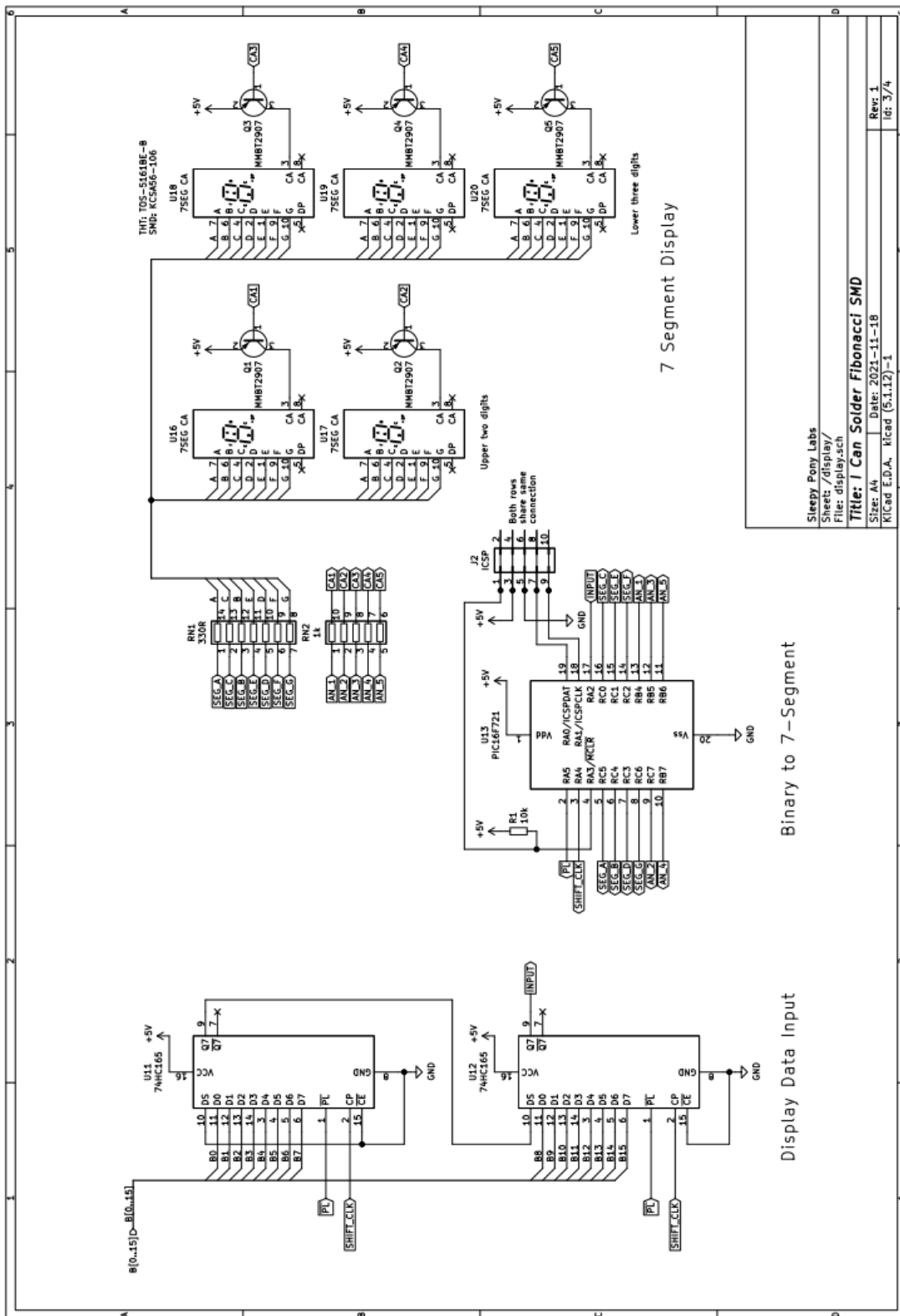

Binary to 7-Segment

Display Data Input

7 Segment Display

Sleepy Pony Labs  
 Sheet: /display/  
 File: display.sch

Title: I Can Solder Fibonacci SMD  
 Size: A4 Date: 2021-11-18  
 Kicad E.D.A. Kicad (5.1.12)-1

Rev: 1  
 Id: 3/4

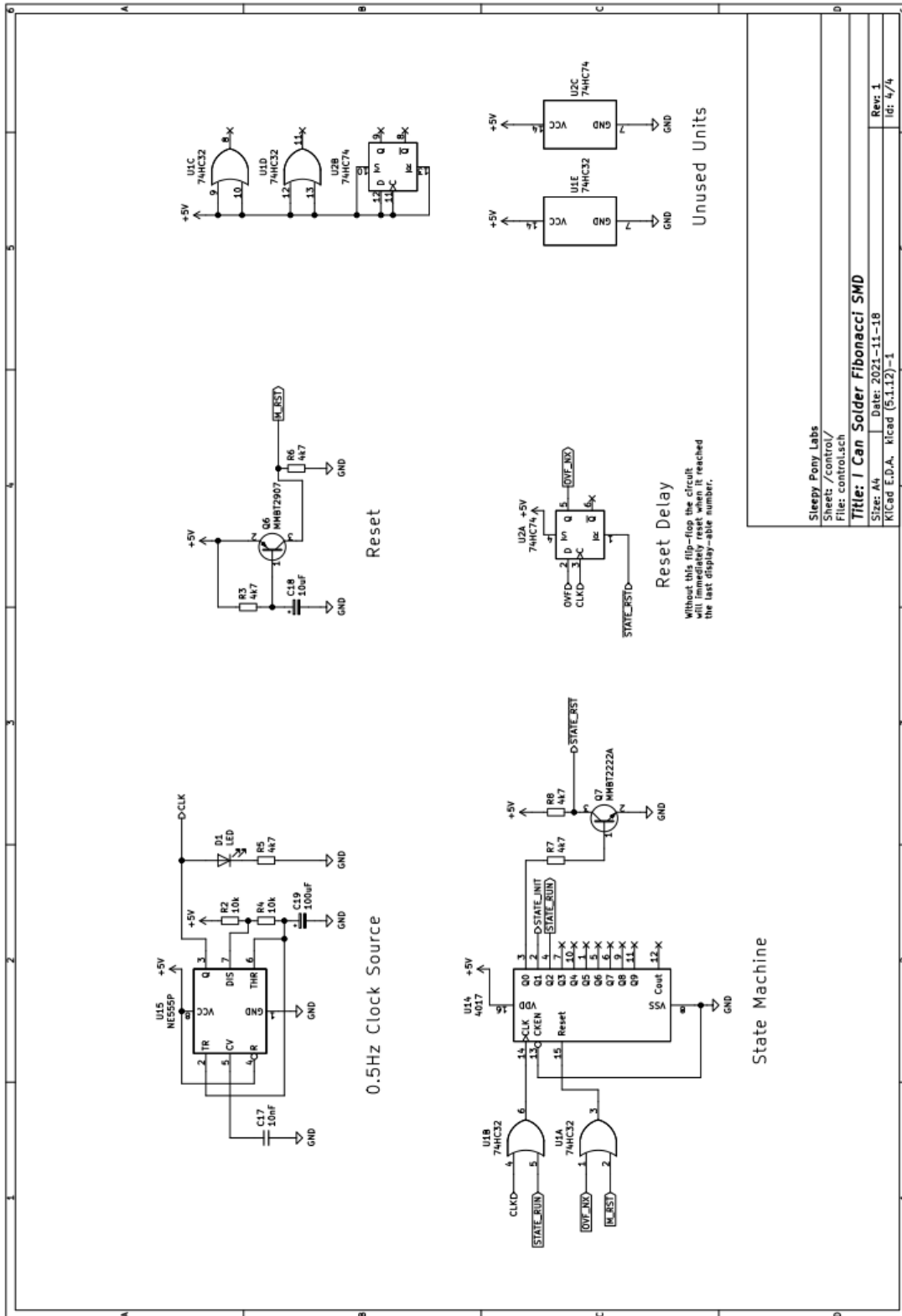

Sleepy Poppy Labs	
Sheet: /control/	
File: control.sch	
<b>Title: 1 Can Solder Fibonacci SMD</b>	
Size: A4	Date: 2021-11-18
Kicad E.D.A. Kicad (5.1.12)-1	
Rev: 1	Id: 4/4

# PCB Layout

## Front

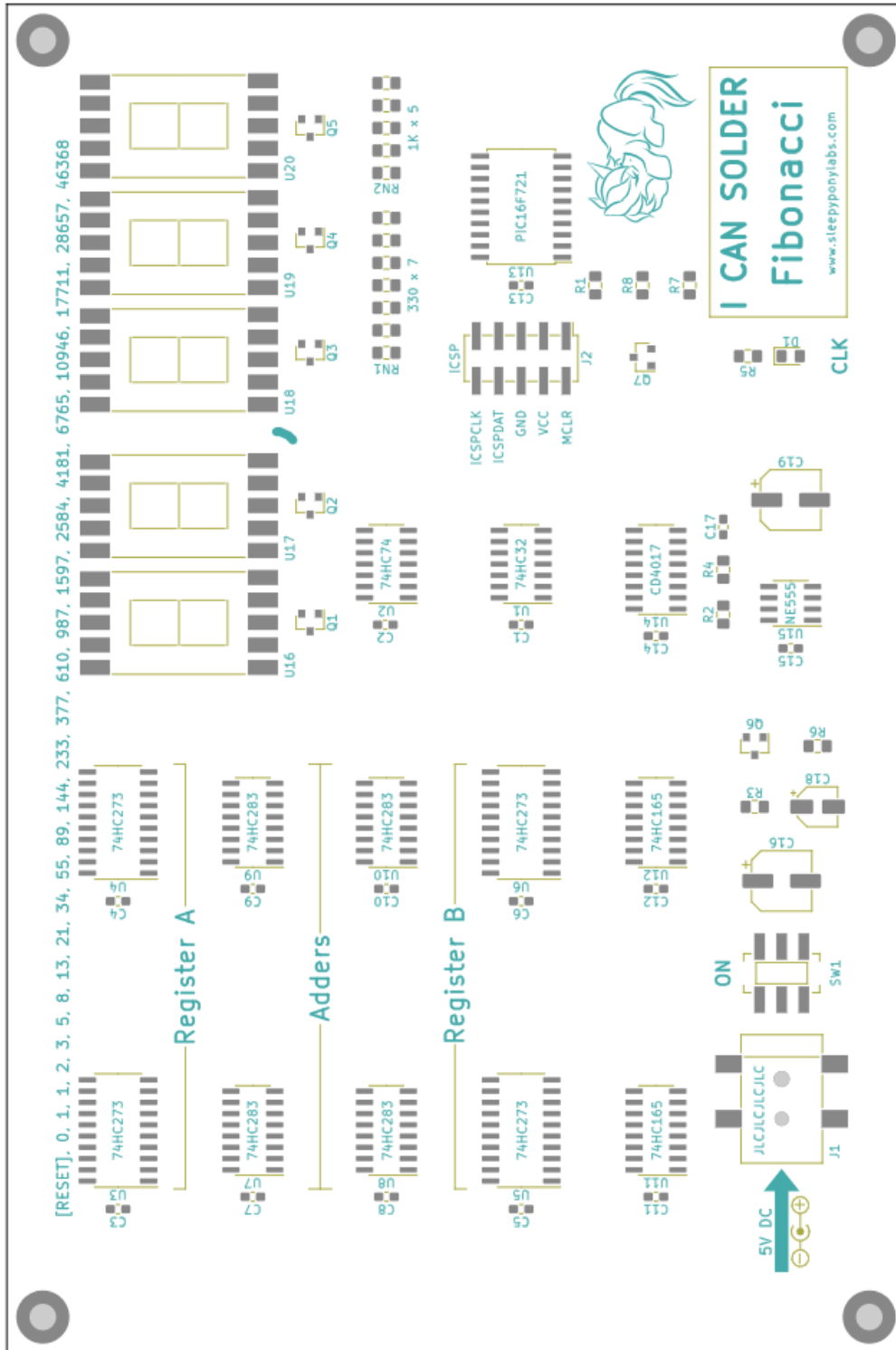

# Fibonacci (THT)

## Information and Assembly Guide



**Sleepy Pony Labs**

sleepyponylabs.com

Document Revision **1** for Board Revision **1**

For the latest updates, visit us at

<https://sleepyponylabs.com/>



# Introduction

Welcome and thank you for purchasing the Fibonacci THT soldering kit from Sleepy Pony Labs! The Fibonacci THT is a soldering practice board that use old-school logic chips to calculate numbers in the Fibonacci sequence from 0 to up to 46,368 and display them on a set of 7-segment display.

This kit is designed for beginners practicing through-hole soldering. There are multiple types of devices available to solder on the board and most of them have duplicates for you to solder multiple times. After you have finished soldering, it could be put into a common 4x6 inches photo frame for show.

## Specifications

- **PCB board:** Green FR4 board of size 4\*6 inches
- **Parts count:** 59 pieces
- **Power supply:** 5v DC adapter, 5.5x2.1 mm, center positive (not included)
  
- **Soldering Difficulty:** 3/10
- **Soldering Type:** THT only, smallest pitch 2.54 mm
  
- **Firmware parts:** PIC16F1578 x1 (with ICSP header)

## Unpacking List / Bill of Materials (BOM)

References	Description	Quantity
C1 – C15	100nF Ceramic Capacitor	15
C16, C19	100uF Electrolytic Capacitor	2
C17	10nF Ceramic Capacitor	1
C18	10uF Electrolytic Capacitor	1
R1, R2, R4	10 kΩ Resistor	3
R3, R5 – R8	4.7 kΩ Resistor	5
RN1	330 Ω Resistor (7x)	1*
RN2	1 kΩ Resistor (5x)	1*
D1	Red LED	1
U1	74HC32 Logic IC	1
U2	74HC74 Logic IC	1
U3 – U6	74HC273 Logic IC	4
U7 – U10	74HC283 Logic IC	4
U11 – U12	74HC165 Logic IC	2
U13	PIC16F1578 Microcontroller	1
U14	NE555 Timer IC	1
U15	CD4017 Logic IC	1
U16 – U20	7-Segment Display (single digit, common anode)	5
SW1	THT Slide Switch	1
Q1 – Q6	2N2907 PNP Transistor	6
Q7	2N2222A NPN Transistor	1
J1	THT DC Jack (5.5x2.5mm barrel)	1
	<b>Total</b>	<b>59</b>

**Note:** RN1 is 7 separate 1/4W resistors, and RN2 is 5 separate 1/4W resistors.

**Note:** High-Resolution image of the PCB is on page 15.

**Note:** ICSP header not included.

**Note:** We strongly recommended that you use the interactive BOM during unpacking and assembling. It will make your life much easier. It is available here: [https://www.sleepyponylabs.com/ibom/html/ibom\\_fibonacci\\_tht\\_rev\\_1.html](https://www.sleepyponylabs.com/ibom/html/ibom_fibonacci_tht_rev_1.html)

# Assembly Guide

The general guide in soldering anything is to solder components with the lowest profile (least in height) first before soldering other taller components.

This guide sums up my experience in soldering the board during the testing. Follow the steps here to reduce possible problems.

## 1. Resistor (Horizontal)

Fold the resistor's legs even with its body, then insert it through the hole. Hold it with tape then solder them. There is no polarity.

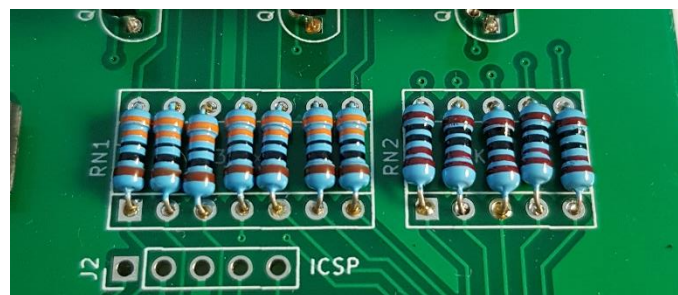

*Note: This is also how you install RN1 and RN2.*

## 2. IC

First, find the pin 1 mark. It will be a dimple or indent on one side of the chip. Align it with the notch marking on the board. Insert the chip into the holes. Be careful not to break any pin. Hold it in and solder two diagonal pins (for example, pin 14 and 28, or pin 1 and 15), then solder the rest of the pins.

You might also want to add IC sockets (not included) so you could easily remove the chips later.

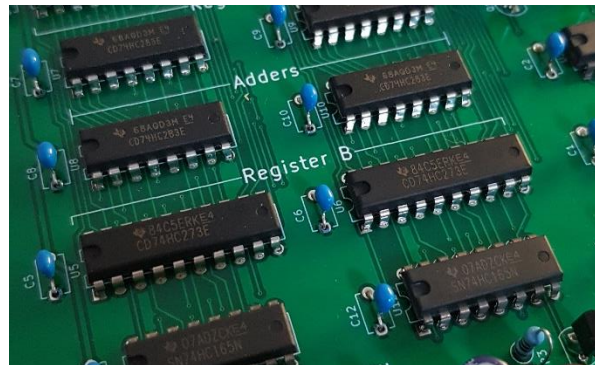

## 3. LED

Insert it through the hole and be careful of the polarity. Align the flat side with the board as shown. Hold it with tape then solder them.



#### 4. Ceramic Capacitor

Insert it through the hole. Hold it with tape then solder them. There is no polarity.

**Note:** The capacitors that come with the kit might have 2.54mm pitch. In this case you will have to pry the legs to make them fit the 5.08mm pitch footprint on the board. However, don't force them or the legs might break off.

#### 5. Resistor (Vertical)

Bend one leg of the resistor 90 degrees, then bend it 90 degrees again. You should now get a vertical resistor with 2.54mm pitch.

Insert it through the hole. Hold it with tape then solder them. There is no polarity.

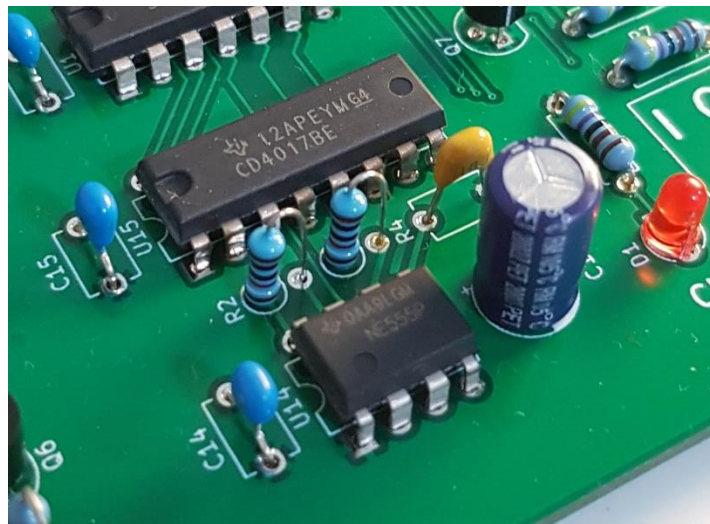

*How to install ceramic capacitors (2.54/5.08mm pitch) and resistors with vertical footprint*

## 6. 7-Segment Display

Place the display on the footprint. Make sure the decimal point is at the bottom of the display. Hold it with tape and solder it.

**Note:** If your display comes with a protective sticker and you plan to clean the board with flux cleaner or alcohol later, leave the sticker intact for now and only remove it after you are done. **Cleaning solutions will dissolve the black display coating.**

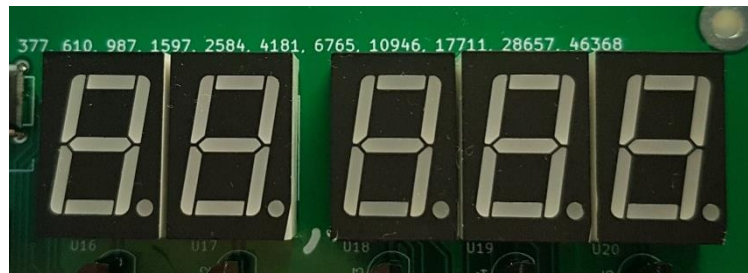

## 7. Transistor (TO-92)

First, face the flat side of the transistor towards you. Then, bend the middle leg of the transistor backward until you can fit it in the footprint. Push it in a little bit until it will go no further (noted that it will not go in all the way). Now it will most likely hold itself on the board and you can then solder it.

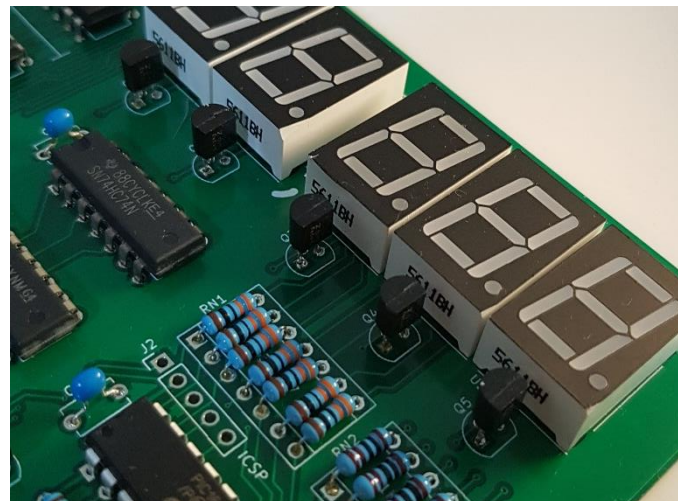

## 8. THT Slide Switch

Insert the switch through the hole and then hold it with tape. Solder the retaining pins on each side of the switch first then solder the rest of the pins.

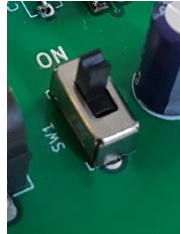

## 9. Electrolytic Capacitors

Insert it through the hole and be careful of the polarity. Hold it with tape then solder them.

**Note:** The white stripe on electrolytic capacitors denotes the negative pin.



## 10. Barrel Jack

Insert it through the hole. Hold it with tape then solder it.

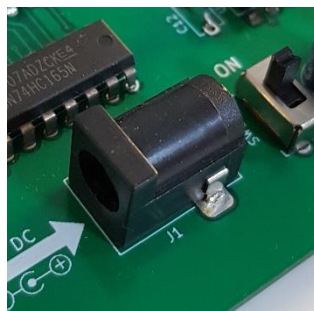

## How to Use

After all the parts were soldered, connect the 5V power source and turn the switch to ON position. All of the 7-segment displays should light up 00000.

Every time the CLK LED flashes, the display should update to the next number in the Fibonacci sequence (as written on the top of the board).

When the display reaches 46368, the highest number that could fit in a 16-bit register, the circuit will reset back to 00000 and start counting from the beginning again. The circuit will loop indefinitely until it is turned off.

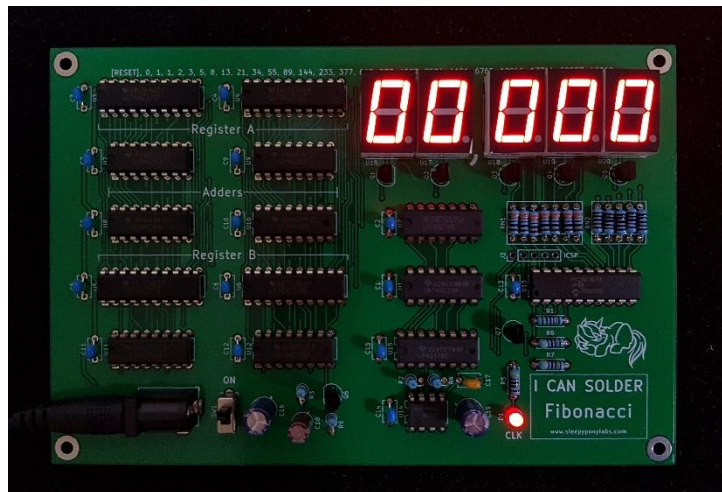

**Correct Power-On Behavior**

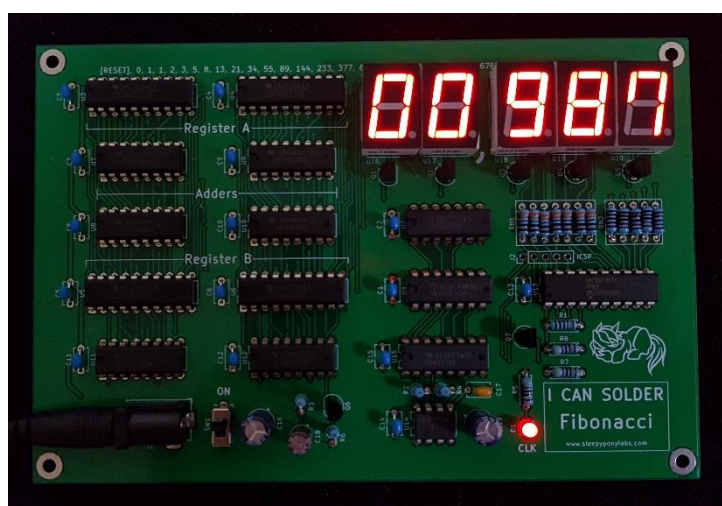

**Correct Running Behavior**



# Troubleshooting

In case your circuit does not work, the list below contains some possible causes of the issue from most likely to least likely:

- Bad solder joints (Cold joints, Short between joints, Unconnected joints)
- Incorrectly installed components (Wrong location or orientation)
- Bad power supply (Battery dry, Wrong type, Wrong polarity)
- Components damaged by soldering heat.
- Components damaged by static electricity or broken from the factory.
- PCB damaged by soldering heat or impact (Broken pads or traces).

And these are possible causes specific to this kit:

- None found so far. If you have something concerning, please contact me on my website or on Tindie. Thanks!

# Schematics

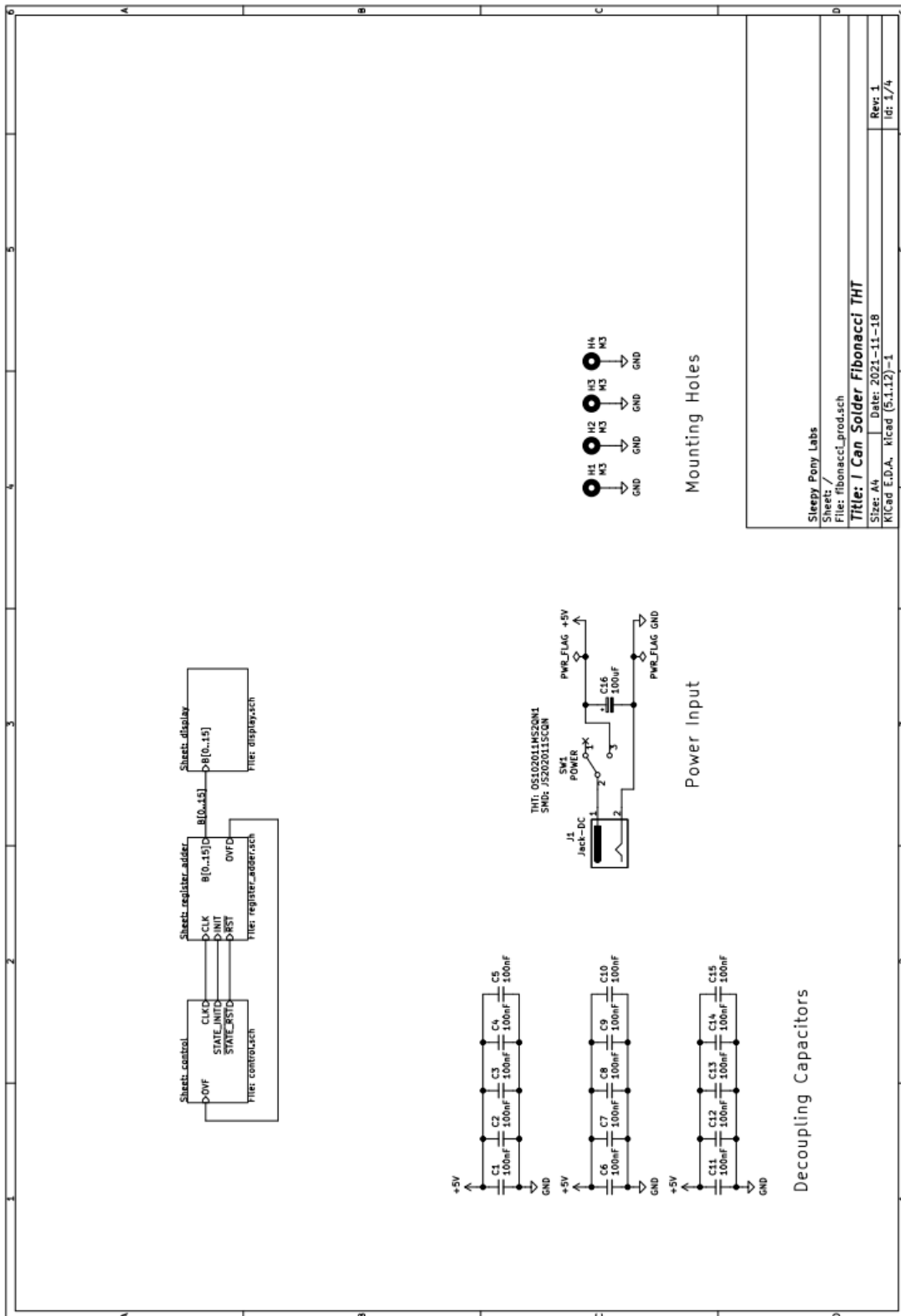

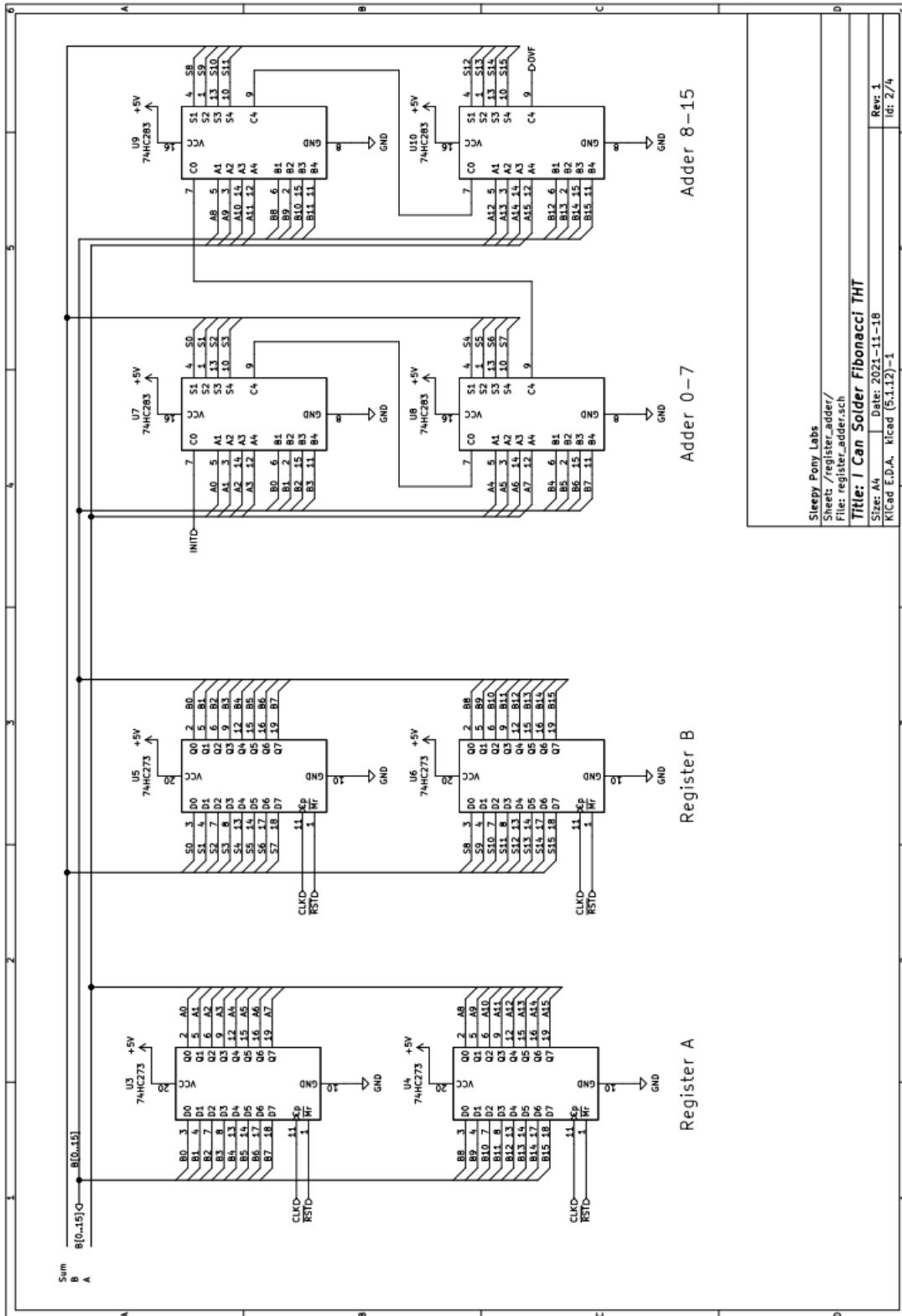

Sineey Popy Labs  
 Sheet: /register\_addr/  
 File: register\_addr.sch  
**Title: 1 Can Solder Fibonacci THT**  
 Size: A4 Date: 2021-11-18 Rev: 1  
 K/Cad E.D.A. K/cad (5.1.12)-1 Id: 2/4

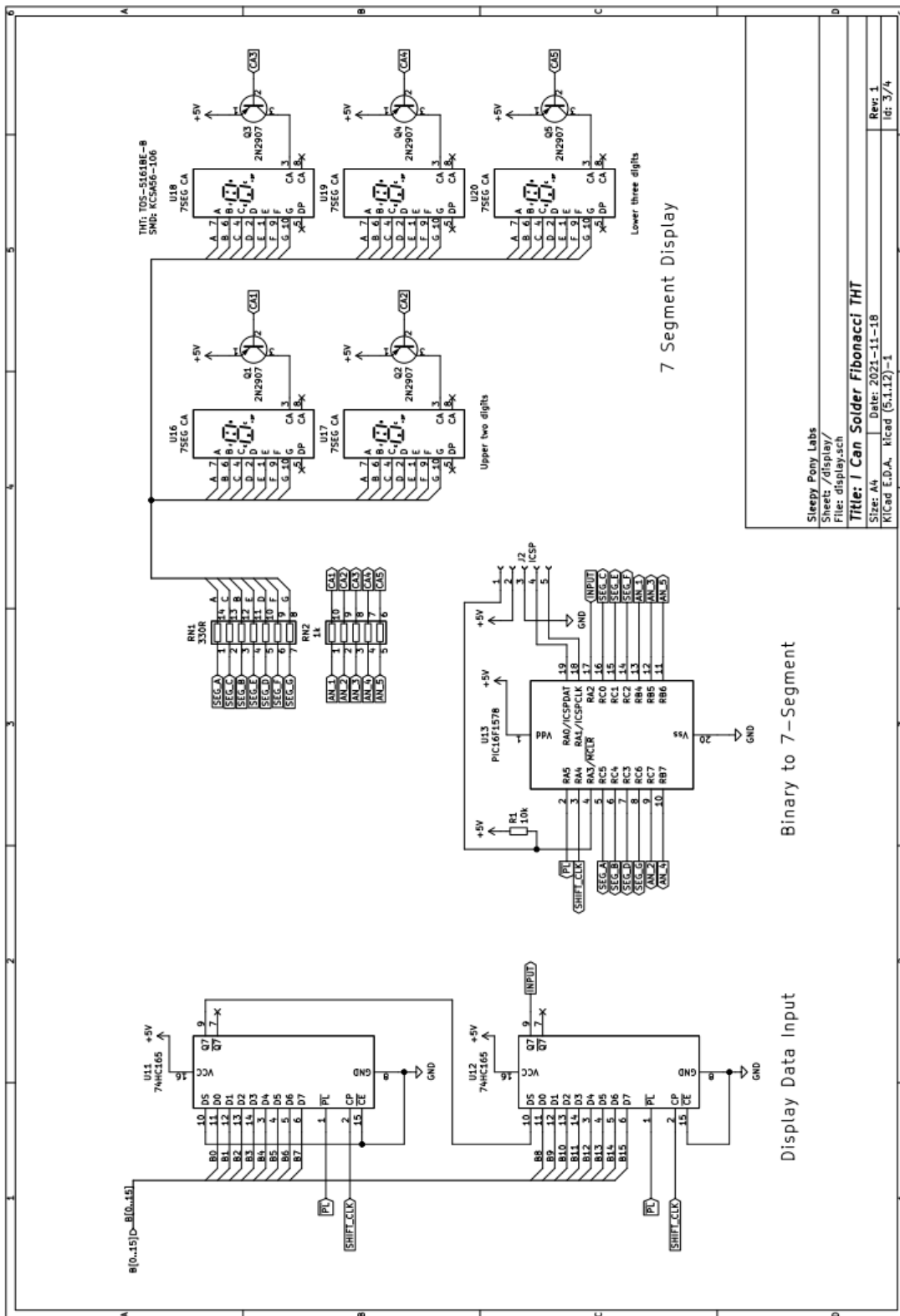

Binary to 7-Segment

Display Data Input

7 Segment Display

Sleepy Pony Labs  
 Sheets / display/  
 Files / display.sch

Title: I Can Solder Fibonacci THT  
 Size: A4 Date: 2021-11-18  
 KiCad E.D.A. Kicad (5.1.12)-1

Rev: 1  
 Id: 3/4

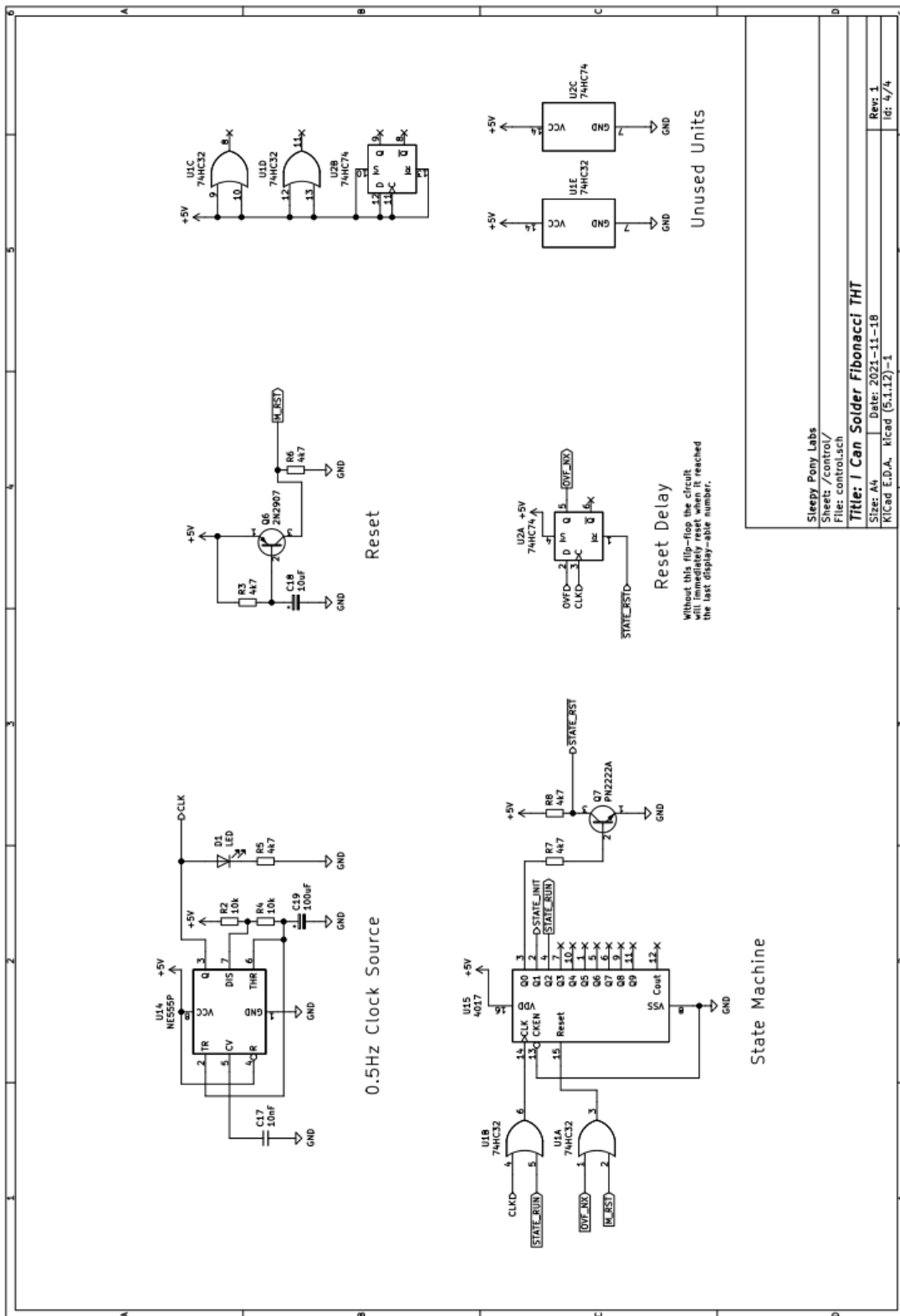

# PCB Layout

## Front

