

5 Channel Multifunctional PWM Controller

HomLiCon LCH5

Application

- Control of groups LED, LED strips, LED modules
- Color Organ, Sound Activated Light Show, Light Sequencer, etc.
- Home Automation

Technical Specifications	
Number of Channels	5
Color organ number of channels	4 + Inverse Channel
Supply voltage	12 V DC (9 – 16 V DC)
Maximum output current per channel	2 A
Maximum total output current	10 A
Current consumption	15 mA
Number of stored levels and settings	10
Color Organ bandwidths	LF 50–200Hz , MF 200Hz–1kHz , MHF 1–7kHz, HF 7–14kHz
Line-in nominal level (set standard / high sensitivity)	0.3 V RMS / 0.15 V RMS
Line-in maximum level	1.5 V RMS
Mic-in range of sound level	60 - 120 dB
PWM steps for each channel	110
Dimensions LCH5	75 x 49 x 20 mm
Dimensions Remote	90 x 40 x 10 mm
Ambient temperature	5 – 40°C







Controller Features

- ✓ Control of all settings and functions through the remote control included in the kit.
- ✓ Three main modes:
 - Color Organ, Sound Activated Light Show
 - Light Sequencer
 - Lighting
- ✓ Easy one-button switching between 10 pre-saved custom groups, different levels for all channels or light show settings.
- ✓ Easy save of 10 custom groups, different levels for all channels or Light Show settings.
- ✓ Activation of Light Show controlled by sound from microphone, Line-in or unsynchronized.
- ✓ Fully automatic Color Organ with AGC (Automatic gain control) and digital division of the bandwidth in 4 range: LF 50 - 200Hz , MLF 200Hz - 1kHz , MHF 1 - 7kHz, HF 7 - 14kHz.
- ✓ Automatic gain control (AGC) : Line-in > 10dB , Mic-in > 60dB
- ✓ Level Meter with / without AGC (Automatic gain control).
- ✓ Automatic or manual switching between different programs of Light Show.
- ✓ Adjust sensitivity AGC (Automatic gain control) for Color Organ separately for each frequency channel LF, MLF, MHF, HF in 4 levels, saved separately for each audio input.
- ✓ Equalize or adjust the light intensity for channels in Light Show.
- ✓ Setting the maximum level for inverse channel in Light Show.
- ✓ Gradually increase or decrease the light intensity when you turn ON or OFF each PWM channel.
- ✓ Gradually increase or decrease the light intensity for all channels to reach the preset levels when you select one of the ten preset functions. Ability to set PWM control for each channel or ON/OFF option.
- ✓ Ability to set PWM control for each channel or ON/OFF option.
- ✓ Ability to choose if the channels are OFF or a saved function is activated when the supply voltage is applied.
- ✓ LED on each one of the channels connected to the microcontroller pins for indication and diagnostics.
- ✓ 5A Power SMD MOSFET for the output of each channel.

1.0 Basic operations and wired diagram



1.1 Light Show basic operations

All operations and settings are performed by the included IR remote control.

Button	Description	More info in section:
	Turns OFF all channels / Turns ON the saved functions for button 9	2.1 2.2
	ON / OFF Light Show	5.1
	Next Light Show program (to 10)	5.2 5.4 5.11
	Previous Light Show program (to 1)	5.2 5.4 5.11
	ON / OFF the synchronization of sound and Light Show (Color organ, Level meter OR Light Sequencer)	5.3
MENU , 	Line input (3.5mm stereo jack). The interval between buttons must not exceed 2 seconds.	5.4
MENU , 	Microphone input The interval between buttons must not exceed 2 seconds.	5.4

Note: See section 5.0 for more details

Table programs of 4 Channel Light Show

Remote control buttons:  ON / OFF ,  Next program (to 10).,  Previous program (to 1)

Nº	Programs with sound control	Programs without sound control
1	AUTO - automatic switching between programs 3 - 10, while at a low sound level - switches to program 2	AUTO - automatic switching between programs 3 - 10
2	Smooth transitions sequence (PWM) without sound control	
3	Color organ with smooth transitions (PWM)	Chaser →
4	Color organ classic	Chaser → , ←
5	Level meter →	Fill → , ←
6	Level meter ←	Chaser dark dot →
7	Level meter single dot →	Chaser ←
8	Level meter 2 dot ←	Fill ← , Chaser ← , etc.
9	Level meter with beat detection shift →	Chaser → , Fill ← , etc.
10	Level meter with beat detection shift ←	Fill →

Table of the Factory Pre Stored Light Show Functions (You can change these settings)

Button	Function	№ Program	Signal input
0	Light Show without sound sync. (Light Sequencer) - AUTO Program	<i>Program 1</i>	–
6	Light Show – Color organ classic	<i>Program 4</i>	Microphone
7	Light Show – Level meter	<i>Program 5</i>	Microphone
8	Light Show – Color Organ smooth transitions (PWM)	<i>Program 3</i>	Microphone
9 	Light Show with sound sync.– AUTO Program – switch between programs 3 - 10, while at a low sound level - switch to program 2 (Smooth transitions sequence (PWM) without sound control)	<i>Program 1</i>	Microphone

Note 1: Button  Turns **OFF** all channels / Turns **ON** the saved functions for button **9**.

Note 2: See section 2.0 for more details

1.2 Wiring diagram and description

The supply voltage 12V DC must be connected to the terminal blocks marked + and - .
 All + terminals of the LED strips / modules must be connected together in a terminal outside the controller and a single wire from this connection must be connected to the terminal marked + L on the controller.
 Each of the - terminals of the LED strips / modules must be connected to terminals 1, 2, 3, 4, 5 respectively.

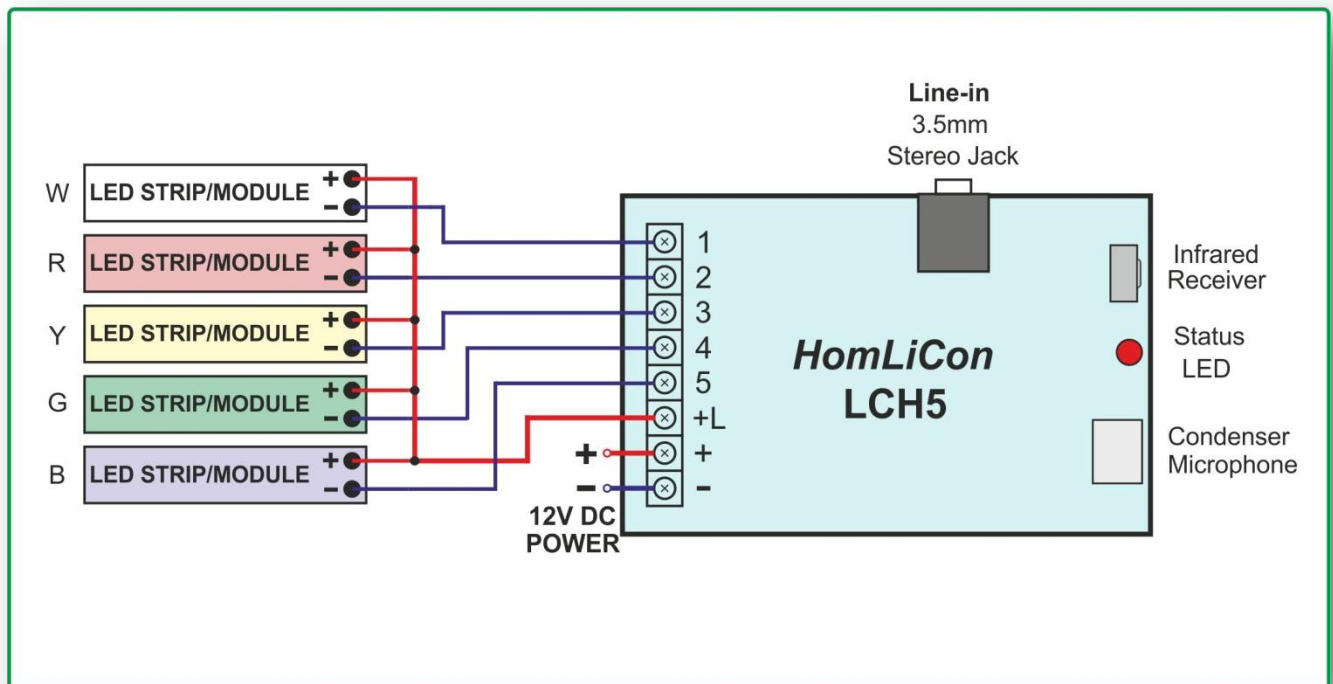

Note: First, install spacers in the mounting holes on the board to protect the installed components.
 More connection options can be found on the last pages.

Warning:

- Outputs do **NOT** have protection from short circuit, overload or reverse voltage. Improper connection will lead to a damaged controller.
- Line-in audio signal must be from the Line-out of a player, computer (green jack) or smartphone. **Do not use a speaker output from amplifier or car audio.** Adjust (increase) the level of the player until the channels start to turn on.
- Individual and/or POWER LEDs must be connected by a series resistor limiting the current to nominal (in LED strips and modules is embedded).
- Do not connect POWER LEDs or LED COBs that are powered by a driver or inverter (small electronic board).

2.0 Stored Functions - Settings and Operation

All operations and settings are performed by the included IR remote control.

2.1 Stored Functions - Easy Switching Between Different Levels and Settings

Buttons **1, 2, 3, 4** and **5** are used for control of the corresponding channels in Lighting mode **or** as part of the ten buttons for stored functions. Switching is performed with the button **MODE**. When buttons **1, 2, 3, 4** and **5** used for channels control, STATUS LED flashes with short pulse (0.01s) and a long pause (2s).

You can quickly switch between the different saved light levels and Light Show settings with the use of the buttons **0, 1, 2, ..., 9**, and the levels will change smoothly until the new values are reached.

Table of the Factory Pre Stored Functions (You can change these settings)

Button	Channel 1	Channel 2	Channel 3	Channel 4	Channel 5
0	Level 10%	Light Show without sound sync. - Program 1 - AUTO Program			
1	Level 100%	Level 30%	Level 100%	Level 30%	Level 100%
2	Level 20%	Level 100%	Level 20%	Level 100%	Level 20%
3	Level 10%	Level 10%	Level 100%	Level 10%	Level 10%
4	Level 10%	Level 40%	Level 40%	Level 100%	Level 40%
5	Level 0%	Level 100%	Level 100%	Level 100%	Level 100%
6	Inverse channel	Light Show - Program 4 - Color organ classic - Microphone-In			
7	Inverse channel	Light Show - Program 5 - Level meter \rightarrow - Microphone-In			
8	Inverse channel	Light Show – Program 3 - Color Organ (PWM) - Microphone-In			
9	Inverse channel	Light Show with sound sync. - Program 1 - AUTO - Microphone-In			

Note 1: Button  Turns **OFF** all channels / Turns **ON** the saved functions for button **9**.

Note 2: **The functions are the highest priority.** No matter what mode is the controller using, the function button will activate the appropriate stored settings. The buttons **0, 6, 7, 8, 9** are always used for switching functions.

2.2 Saving Functions

You can save the present levels and Light Show settings in the non-volatile memory by sequentially pressing and releasing the buttons **MENU** and one of **0, 1, 2, ..., 9** (the interval between pressing the buttons should not exceed 2 seconds).



List of the settings are stored separately for each of the buttons from **0** to **9** :

- ✓ Levels of the channels (Lighting mode)
- ✓ ON/OFF Light Show

If Light Show is activated:

- ✓ The present program
- ✓ Programs with or without sound synchronization
- ✓ Audio input: Line-in or Microphone
- ✓ 4 channel Light Show (channels 2, 3, 4, 5) or 3 channel (channels 3, 4, 5)
- ✓ ON/OFF inverse channel (channel 1)

Note:

- The Light Show settings are stored separately for each function button **0** to **9** and the button  for a total of 11 groups. Changing one setting will save all active at that time, only for the button .
- The settings for each function key **0** to **9** are saved only with the buttons **MENU**, **0** to **9**.
- Light Show can not be activated if it is disabled by the sequence: **MENU**, , **0**. You can find more info about these settings on section **5.13**.

3.0 Lighting mode - Channels control

3.1 Setting the levels for the channels

The controller is in lighting mode when the light show is OFF.

Buttons **1, 2, 3, 4** and **5** are used for control of the corresponding channels or as part of the ten buttons for stored functions. Switching is performed with the button **MODE** - alternatively. When buttons **1, 2, 3, 4** and **5** are used for channels control, STATUS LED flashes with short pulse (0.01s) and a long pause (2s).

A single button system is used for regulating each channel and it is as follows:

- I. By pressing and releasing the button for specific channel the light's intensity is increasing.
 - II. After the next pressing and releasing it is fixed on the current level.
 - III. After pressing and releasing again - the light's intensity is decreasing.
 - IV. After the next pressing and releasing it is fixed on the current level.
- By repeating steps I - IV or part of them the required level can be reached.

For more precise adjustment the + and - buttons can be used. They regulate the last channel that was used, or the selected one by pressing and releasing the button OK and the button for the specific channel (1 to 5).

Note: The options for controlling the device have the following priority:

1. Buttons for functions
2. Light Show control buttons
3. Buttons for channels control

3.2 Adjusting the speed of smooth transitions when switching channels

The speed settings of smooth channels switching and speed settings in Light Show program 2 – “Smooth transitions sequence” is the same.

The adjustment can be made in the light show program 2 by **+** and **-** buttons.
You can find more info about these settings on section **5.9**.

3.3 Setting the channels in PWM or ON/OFF mode

You can switch certain channels in PWM or ON/OFF by turning on the necessary channels for ON/OFF mode and sequentially press and release the **MENU**, **MODE**, **1** ((the interval between pressing each of the buttons should not exceed 2 seconds). With this combination, the turned ON channels are stored in non-volatile memory with function ON/OFF, and the turned OFF channels with PWM. After such a change it is recommended the stored values and settings for buttons **0, 1, ..., 9** to be made again.

Note: Channels that are in ON/OFF mode do not work correctly in Light Show.

3.4 Table of General Settings

Settings changes can be made by successively pressing and releasing the following buttons:

MENU , MODE , 1	Switching certain channels of PWM or ON / OFF can be made by turning ON the necessary channels for ON/OFF mode and sequentially press and release the MENU, MODE, 1 . With this combination, the turned ON channels are stored in non-volatile memory with function ON/OFF, and the turned OFF channels with PWM. After such a change it is advisable the stored values and settings 0, 1, ..., 9 to be set again.
MENU , MODE , 7	After applying the supply voltage, the channels are OFF. [DEFAULT]
MENU , MODE , 8	After applying the supply voltage, turns on the saved functions for button 9 .
MENU , MODE , 0	Reset the user settings and return the original (factory) or just reboot. It activates STATUS LED - ON/OFF in 0.1 seconds, while awaiting confirmation with button + to return to initial (factory) settings, button - for RESET or another button to exit.

Note: The interval between each button must not exceed 2 seconds.

3.5 Hardware return to factory settings

- 1) Turn Power OFF
 - 2) Temporarily connect the pads marked as J13.
 - 3) Turn Power ON
- After 2-3 seconds or when STATUS LED turns ON :
- 4) Turn Power OFF
 - 5) Remove the connection between the pads marked as J13.

4.0 Status LED Indication





For indication of the received infrared pulses and the current state of some features is used **STATUS LED**. When the buttons **1, 2, 3, 4** and **5** are used for the control of specific channel in Lighting mode, **STATUS LED** flashes with short pulse (0.01s) and a long pause (2s). After pressing the button **MENU** the status LED is activated for 2 seconds (on/off in 0.1 sec.) as indication for waiting for the next button to be pressed.

5.0 Light Show Control and Settings

5.1 Turning ON / OFF Light Show



Turn ON / OFF Light Show by pressing button .

Note:

- When Light Show is activated by pressing button , the last saved settings will be activated instead of the last used settings by the function keys **0** to **9**. The Light Show settings are stored separately for each function button **0** to **9** and the button  for a total of 11 groups. Changing one setting will save all active at that time, only for the button .
- Light Show can not be activated if it is disabled by the sequence: **MENU** ,  , **0**. You can find more info about these settings on section **5.13**.

5.2 Switching programs

You can switch between programs with the buttons:

-  next program (to 10)
-  previous program (to 1)

5.3 Switching between programs with/without sound control

The button  is used (if Light Show is activated) to switch between two groups of programs:

- programs with sound control - Color organ, Level meter, etc.
- programs with self patterns - Chaser, moving light, etc.

5.4 Switching between audio inputs

You can switch between audio inputs with the following key sequence:

- **MENU** ,  - Line-in
- **MENU** ,  - Microphone

The interval between each button must not exceed 2 seconds.

5.5 Setting Line-in Audio Sensitivity

When using a Line-in, you can choose between **two** sensitivity levels with the buttons:

- Standard sensitivity (default)
- + High sensitivity

To adjust the sensitivity of the line input, the controller must be set to one of the Light Show programs with sound control (programs 3 to 10 - Color organ, Level meter, etc.).

First pressing one of the **+** or **-** buttons only serves to indicate the current sensitivity state for a period of 2 seconds:

Standard sensitivity - channel 3 ON (green)
High sensitivity - channel 4 ON (blue)

Note 1: Press the **OK** button before adjusting the sensitivity if you have already made other settings (eg those in section 5.7).

Note 2: This setting is unavailable when using the microphone input.

5.6 Setting maximum brightness levels for channels in Light Show and Inverse Channel

Some colors LEDs are brighter than others. With this option, you have the ability to equalize brightness. You can equalize or adjust the light intensity for channels in Light Show and set the maximum level for inverse channel.

5.6.1 View maximum brightness levels for channels in Light Show and Inverse Channel

You can visualise the present levels with key sequence: **OK** , **▶||** (Light Show must be switched OFF).

5.6.2 Setting maximum brightness levels for channels in Light Show and Inverse Channel

1. Turn OFF Light Show (button **▶||** or **⏻**) .
2. Set the channels to desired levels(See section 3.1) or visualise the present levels with key sequence: **OK** , **▶||** and adjust them.
3. Save the new levels by pressing and releasing the following buttons:
MENU , **▶||** , **OK** .

Note:

- The interval between each button must not exceed 2 seconds.
- This setting does not affect program 2 – “Smooth transitions sequence (PWM) without sound control”.
- For proper operation of Light Show program 3, the maximum level of channels should not be less than 15%.

5.7 Setting Audio Sensitivity AGC (Automatic gain control) for Color Organ

You can adjust sensitivity AGC for Color Organ separately for each frequency channel LF, MLF, MHF, HF in 4 levels. These settings are saved separately for each audio input - for 4 frequency channels on Line-In and for 4 on Microphone-In.

To adjust the sensitivity, the controller must be set on one of the two programs for Color Organ (program 2 or 3), and buttons 1 to 5 must be set for channels control (button **MODE** - status led flashes with short pulse 0.01s and a long pause 2s).

The selection of the channel that you want to adjust is made by pressing one of the buttons 2, 3, 4, 5 respectively for frequency channels LF, MLF, MHF, HF. By pressing one of the buttons 2 to 5, the present level of sensitivity is displayed on the output channels 2, 3, 4, 5 as a level bar, where level 1 (which is the lowest sensitivity) will turn on channel 2 and level 4 (which is the highest sensitivity) will turn on channels 2,3,4 and 5. The selection of a channel is active until another channel is selected or the program is switched.

Table of Sensitivity level AGC

Sensitivity level AGC	Sensitivity displayed on the output channels 2, 3, 4, 5	Sensitivity level AGC	Sensitivity displayed on the output channels 2, 3, 4, 5
1 (lowest)	☀ ● ● ●	3	☀ ☀ ☀ ●
2	☀ ☀ ● ●	4 (highest)	☀ ☀ ☀ ☀

The adjustment for the selected frequency channel is made by buttons **+** and **-** , and the levels are visualized on the output channels 2, 3, 4, 5. Pressing the button once serves only for visualization. Pressing it again serves for regulation. After the change of sensitivity it takes some time (3 – 15s) for activation of the new settings.

Table of the Factory Pre Stored Levels Sensitivity (You can change this settings)

Frequency channel	Button to select	Line-In factory pre stored level	Line-In level displayed on the output channels 2, 3, 4, 5	Microphone-In factory pre stored level	Microphone-In level displayed on the output channels 2, 3, 4, 5
LF	2	3	☀ ☀ ☀ ●	4	☀ ☀ ☀ ☀
MLF	3	3	☀ ☀ ☀ ●	4	☀ ☀ ☀ ☀
MHF	4	3	☀ ☀ ☀ ●	4	☀ ☀ ☀ ☀
HF	5	3	☀ ☀ ☀ ●	4	☀ ☀ ☀ ☀

5.8 Adjusting the speed in the programs without sound synchronization

You can adjust the speed of programs without sound synchronization by buttons + and - .

5.9 Adjusting the speed in program 2 – “Smooth transition sequence”

You can change the speed of the smooth transition in program 2 – “Smooth transition sequence (PWM) without sound control” with buttons + and - .

Note: This setting affects the speed of smooth transitions when switching channels in Lighting mode.

5.10 Determining the optimal voltage of the audio signal - Level meter without AGC (Automatic gain control)

To determine the optimal audio signal level (Line-In only), you can temporarily turn OFF the AGC. When program 5 is active (Level meter →) you can select the use of the AGC:

- Button **4** - turn ON AGC (default)
- Button **5** - turn OFF AGC

Table of input voltage when the AGC is turned OFF for the corresponding display of channels 2, 3, 4, 5

Line-In input voltage (RMS)	Level displayed on the output channels 2, 3, 4, 5	
Standard / High sensitivity	Program 5 Level meter →	
0.1V / 0.05V	☀ ● ● ●	Low level
0.2V / 0.1V	☀ ☀ ● ●	Optimal level
0.4V / 0.2V	☀ ☀ ☀ ●	Optimal level
0.5V / 0.25V	☀ ☀ ☀ ☀	High level

The level is optimal when channels 1 and 2 are ON and channel 3 is flashing.

Note:

1. This setting will not be saved. Exit from program 5 automatically turns ON the AGC.
2. Program 5 and switched OFF AGC can be saved to a function key (see section 2.2).
3. AGC can be turned OFF when MIC-IN is active. The voltages for switching ON channels 1 - 4 are respectively: 0.25V, 0.5V, 1V, 1.25V.

THERE ARE TWO TYPES OF LIGHT SHOW ACCORDING TO THE NUMBER OF CHANNELS USED :

5.11 4 Channel Light Show (channels 2, 3, 4, 5)

TABLE PROGRAMS OF 4 CHANNEL LIGHT SHOW

№	Programs with sound control	Programs without sound control
1	AUTO - automatic switching between programs 3 - 10, while at a low sound level - switches to program 2	AUTO - automatic switching between programs 3 - 10
2	Smooth transitions sequence (PWM) without sound control	
3	Color organ with smooth transitions (PWM)	Chaser →
4	Color organ classic	Chaser →, ←
5	Level meter →	Fill →, ←
6	Level meter ←	Chaser dark dot →
7	Level meter single dot →	Chaser ←
8	Level meter 2 dot ←	Fill ←, Chaser ←, etc.
9	Level meter with beat detection shift →	Chaser →, Fill ←, etc.
10	Level meter with beat detection shift ←	Fill →

In this mode **Channel 1** can be used for:

- **Inverse Channel.** When the channels 2, 3, 4 and 5 are OFF, channel 1 is switched smoothly to previously stored level. It works only for 4 channel light show and synchronization with sound.
- Backlight with adjustable level 0 - 100%.

5.12 3 Channel Light Show (channels 3, 4, 5)

The available programs that can be used are from 1 to 6 (view Table programs of 4 Channel Light Show). Setting Audio Sensitivity AGC is not available, but the corresponding values from 4 Channel Light Show [channel MF= (MLF + MHF) /2] is used.

In this mode **Channel 1** and **Channel 2** can be used for backlight with adjustable level 0 - 100%.









5.13 Table of General Settings for Light Show

Settings changes can be made by successively pressing and releasing the following buttons:

MENU , ► , 0	Disable Light Show
MENU , ► , 3	Enable 3 channel Light Show - used channels 3, 4 and 5
MENU , ► , 4	Enable 4 channel Light Show - used channels 2, 3, 4 and 5. [DEFAULT]
MENU , ► , 5	Disable the use of inverse channel
MENU , ► , 6	Allow the use of channel 1 for inverse channel. When the channels 2, 3, 4 and 5 are off, channel 1 is switched smoothly to previously saved level. It works only for Light Show with 4 channels and synchronization with sound. [DEFAULT]
MENU , ► , 7	The range of low frequencies for color organ are set to 50 - 180Hz [DEFAULT]
MENU , ► , 8	The range of low frequencies for color organ are set to 50 - 250Hz. It is recommended when using speakers that do not reproduce low frequencies well.

Note: The interval between each button must not exceed 2 seconds.

6.0 Description of the remote control buttons

Button	Description	More info in section:
	Turns OFF all channels / turns ON the saved functions for button 9 .	
MENU	Save the present levels and Light Show settings in the non-volatile memory by successively pressing and releasing the buttons MENU and one of 0, 1, 2, 3, 4, 5, 6, 7, 8, 9	2.2 3.4 5.13
	ON / OFF the synchronization of sound and Light Show (Color organ, Level meter OR Light Sequencer)	5.3
MODE	You can choose between buttons 1, 2, 3, 4 and 5 to control the respective channels, or as a part of the ten buttons (0 - 9) for stored functions. When the buttons 1 - 5 are used for control of the respective channels, STATUS LED flashes with short pulse (0.01s) and a long pause (2s).	2.1 3.1 3.4
	Turns all channels ON.	
	ON / OFF Light Show.	5.1
	Next Light Show program (to 10) ; MENU ,  - Line-in	5.2 5.4
	Previous Light Show program (to 1) ; MENU ,  - Mic-in	5.2 5.4
OK	Select a channel to be precisely tuned with + and - Sequentially press and release OK and one of 1, 2, 3, 4, 5 .	3.1
- +	Lighting mode: Regulating the last used channel or the selected one. Light Show - Programs with sound control: - Standard sensitivity (default), + High sensitivity Light Show - Programs without sound synchronization: Speed control	3.1 5.5 5.7 5.8 5.9
1, 2, 3, 4, 5	Adjusts or turns ON / OFF the respective channel. ⁽¹⁾	2.1 2.2 5.7 5.10
0, 1, 2, 3, 4, 5, 6, 7, 8, 9	Switch between the saved Functions. ⁽¹⁾	2.1 2.2 3.1

NOTE 1: Buttons **1, 2, 3, 4** and **5** are used to control the respective channels or as part of the ten buttons (**0 - 9**) for stored functions. Switching is performed by the button **MODE**. When they are used for channels control, STATUS LED flashes with short pause (0.01s) and a long pause (2s).

Arrangement of the buttons on the remote control:



Battery CR2025 (not included in kit)

