

IBK-BLUEIO Rev 1

Breakout board for IMM-NRF5x Series Bluetooth micro-module

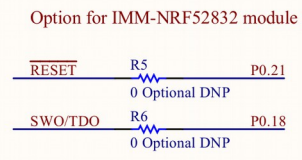

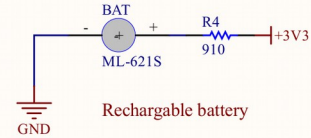
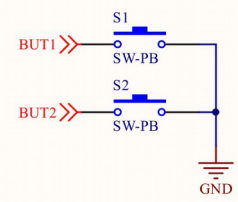
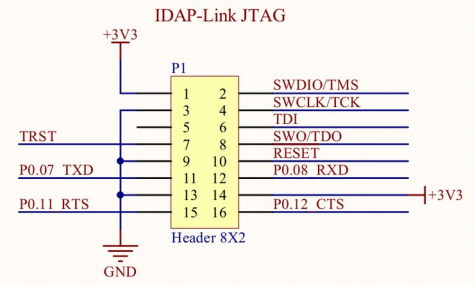
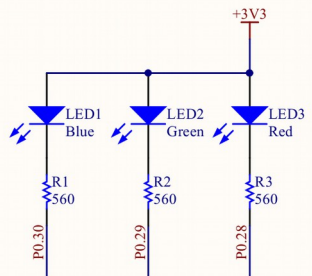
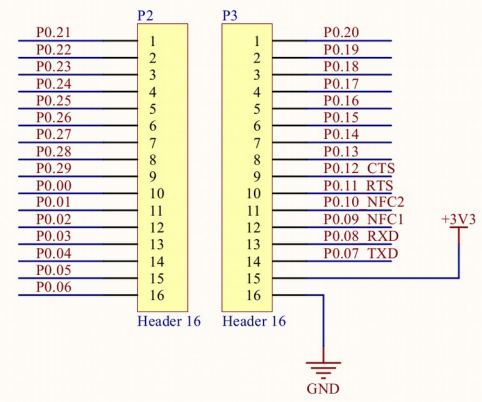
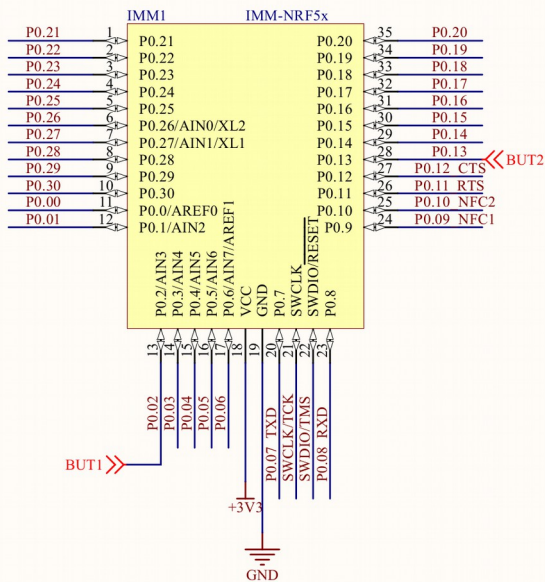
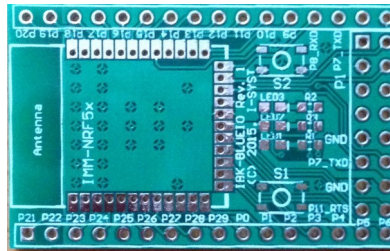
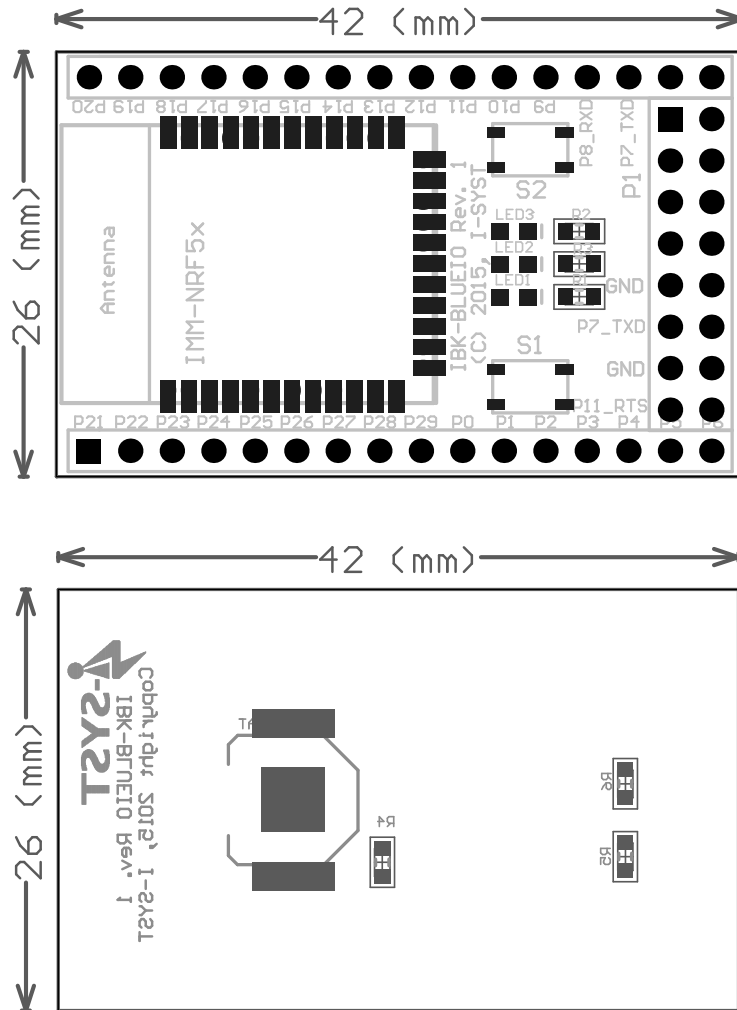

Important note : This breakout board does not have battery over charge protection. Do not leave battery on charge for extended period.

Bill of materials

ITEM	Ref	Package	Value	Qty
1	BAT		KEYSTONE 2998 Coin battery holder Bat: Panasonic ML-621S	1
2	LED1	0603	Chip LED 0603 Blue	1
3	LED2	0603	Chip LED 0603 Green	1
4	LED2	0603	Chip LED 0603 Red	1
5	R1, R2, R3	0603	Resistor 560 Ohm	3
6	R4	0603	Resistor 910 Ohm	1
7	R5, R6	0603	Resistor 0 Ohm Optional for IMM-NRF52832 only	2
8	S1, S2		Push Button PTS810	1