

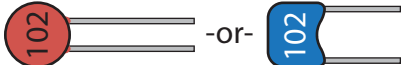





Make sure you have everything before you start soldering!

CAPACITORS

- 10µF Electrolytic** **x2**

 C1, C5
- 1 nF Ceramic** **x1**
 -or- 
 C2
- 100µF Electrolytic** **x1**

 C3
- 0.1µF Ceramic** **x2**
 -or- 
 C4, C6

DIODES

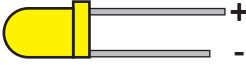
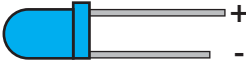

- 1N4148** **x1**

 D40

LEDS

- 3mm - Red** **x3**

 D1, D35, D36
- 3mm - Yellow** **x14**

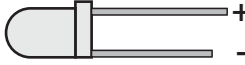
 D2, D21-D25, D28-D34, D37
- 3mm - Blue** **x17**

 D3, D5-D20

Continued...

- 3mm - True Green** **x2**

 D4, D39
- 3mm - Orange** **x1**

 D26
- 3mm - Green** **x1**

 D27
- 3mm - White** **x1**

 D38

CONNECTORS

- 3.5mm Jack** **x19**

 J1-J19
- 10P Box Header** **x1**

 P3

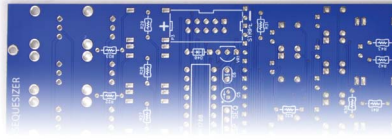

PCBs / PANELS

- Main PCB** **x1**

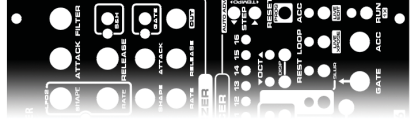
 PCB1



Continued...

- Front Panel** **x1**

 PCB2

POTENTIOMETERS

- 10k** **x12**

 R1-R6, R8-R13
- 1M** **x1**

 R7
- 1k Trim Pot** **x1**

 R14

RESISTORS

- 4.7k 1/8W** **x3**

 R15, R37, R38
- 510Ω 1/8W** **x2**

 R16, R36
- 1k 1/8W** **x17**

 R17-R29, R35, R39-41

Continued...

Make sure you have everything before you start soldering!

100Ω 1/8W x5



R30-R34

100k x2



R42, R43

SWITCHES / BUTTONS

Tact Switch - 6mm x23



13mm High

S1-S23

ICs

PIC16F1718 x1



PIC16F1718

U1

PIC16F1788 x1



PIC16F1788

U2

VOLTAGE REGULATORS

L4931CZ50 (5V) x1

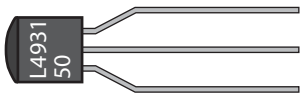

L4931CZ50

VR1

TL431 x1

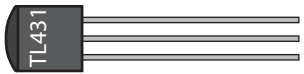

TL431

VR2

HARDWARE

28 Pin IC Socket x2



Hex Standoff x2



0-80 x 3/8"

Silver Screw x2



0-80 x 1/8"

Black Screw x2



0-80 x 1/8"

LED Spacer x39



3mm x 7mm Tall

ACCESSORIES

Euro Power Cable x1



Rack Screw Kit x1



 Assembly instructions can be found at division-6.com/sequesizer