

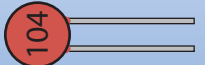





Make sure you have everything before you start soldering!

CAPACITORS

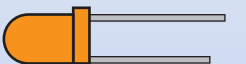
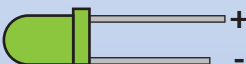
- 10µF Electrolytic** **x2**

 C1-C2
- 0.1µF Ceramic** **x2**

 C3-C4

LEDs

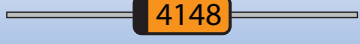
- 3mm - Blue** **x32**

 D1-16, D36-51
- 3mm - Yellow** **x26**

 D17-21, 24-30, 33, 52-56, 59-65, 68
- 3mm - Orange** **x2**

 D22, D57
- 3mm - Green** **x2**

 D23, D58
- 3mm - Red** **x4**

 D31-32, D66-67
- 3mm - White** **x2**

 D34, D69
- 3mm - True Green** **x2**

 D35, D70

DIODES

- 1N4148** **x1**

 D71

CONNECTORS

- 3.5mm Jack** **x12**

 J1-12
- or-

 Optional Banana Jacks
- 10P Box Header** **x1**

 P3



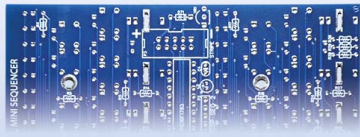
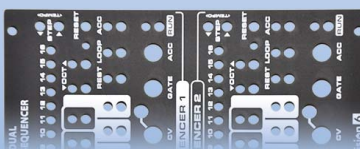

PCBs / PANELS

- Main PCB** **x1**

 PCB1
- Front Panel** **x1**

 PCB2

RESISTORS

- 1K Trim Pot** **x2**

 R1, R2

Continued...

- 100Ω** **x10**

 R3-7, R16-20
- 1K** **x8**

 R8, R12-14, R21, R25-27
- 510Ω** **x2**

 R9, R22
- 4.7K** **x4**

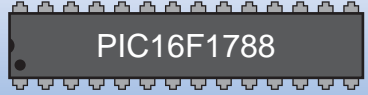
 R10, R11, R23, R24
- 100K** **x4**

 R15, R28, R29, R30

BUTTONS / SWITCHES

- Tact Switch - 6mm** **x42**

 S1-S42

ICs

- PIC16F1788** **x2**

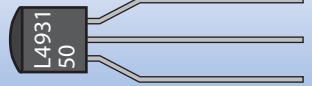
 U1, U2

VOLTAGE REGULATORS

- L4931CZ50 (5V)** **x1**

 VR1

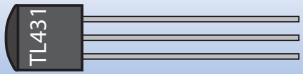
Continued...

TL431 x2



VR2, VR3

HARDWARE

28 Pin IC Socket x2



Hex Standoff x4



Silver Screw x6



Black Screw x2



LED Spacer x70



ACCESSORIES

Euro Power Cable x1



Rack Screw Kit x1



 Assembly instructions can be found at division-6.com/dualsequencer

